

Best Management Practices for Trapping Beaver in the United States





Figure BV1. Beaver
(*Castor canadensis*)

Best Management Practices (BMPs) are carefully researched educational guides designed to address animal welfare and increase trappers' efficiency and selectivity. The extensive research and field-testing used to develop BMPs are described in the Introduction section of this manual. The evaluation methods used to develop BMPs have been standardized, enabling them to be easily updated and revised as new traps and techniques become available. All traps listed in the BMPs have been tested and meet performance standards for animal welfare, efficiency, selectivity, practicality and safety.

Trapping BMPs provide options, allowing for discretion and decision making in the field. BMPs are meant to be implemented in a voluntary and educational approach and do not present a single choice that can or must be applied in all cases. BMPs are the product of ongoing work that may be updated as additional traps are identified through future scientific testing.

The Beaver at a Glance

Characteristics

The beaver (*Castor canadensis*) (Figure BV1) is the only member of the Castoridae family found in North America. It is the largest of the rodents of North America with adults weighing between 26 and 90 pounds, and ranging from 34 to 54 inches in length. Individuals weighing over 100 pounds have been documented. The sexes cannot be distinguished based on size or other external physical characteristics, except for lactating females. The pelage color of most beavers is reddish dark brown, though the fur may be black, pale silver or even blonde.

Range

Beaver occur throughout North America with the exception of arid and desert environments and the Florida peninsula. The range extends far into Canada, but excludes the area above the Arctic Circle. Beavers are rarely encountered in Mexico, except in isolated pockets along the United States border.

Habitat

The beaver is highly adapted to freshwater environments and will rarely venture far from a water source. Beavers live in and along lakes, wetlands, rivers and streams. In locations where slow running water is present, extensive dams are often constructed. In such environments, beavers will often construct a den in a high stream bank. In still waters beavers often build lodges from tree limbs and other debris.

Food Habits

Beavers are strict herbivores and their food habits depend highly on the season. In the spring and fall, their diet is about half woody vegetation and half non-woody vegetation. In the summer months the amount of non-woody vegetation increases to about 90 percent. In the winter months, woody vegetation makes up 100 percent of the diet. When consuming woody plants, beavers generally eat the bark and cambium layer above the wood layer.

Reproduction

The breeding season for beavers varies based on latitude. In the southern United States the breeding season occurs from October through March, while farther north breeding begins in January or February, generally concluding by late March. The gestation period is 105 to 107 days, with only one litter per year being produced. The average litter size is three to four young (kits), with extremes of one to eight. Large litters are typically born in favorable environmental conditions and to older, larger females. Beavers do not reach sexual maturity until they are 18-21 months of age. Individuals do not breed until at least their second year of life, but it is more common to begin breeding in the third year. Young rarely leave the den before one month of age.

Populations

Prior to European settlement, an estimated 60 million beaver inhabited the species' North American range, and in favorable habitat a density of 50 beavers per square mile was possible. However, unregulated harvest of beaver and major habitat changes related to intensive logging and grazing resulted in many populations being vastly reduced or exterminated by 1900. As a result of reintroductions, protection and regulated harvest, beaver populations rebounded across their North American range in the latter part of 20th century. Populations continue to thrive today to the extent that intensive management is often required to prevent damage to private and public properties and to protect public drinking water supplies due to flooding caused by beavers.

How to Avoid Capturing River Otter When Trapping Beavers

Because river otter and beaver often use the same habitat, and harvest regulations often vary by species, there may be times/places when trappers need to avoid capturing river otter. While no method can completely eliminate accidental river otter captures, there are methods that can help reduce the risk of accidental capture, and considering these methods will improve the ability to manage both beaver and river otter populations. The following ideas are offered as a guide to improving selectivity, recognizing that each may have advantages/disadvantages depending on the situation and location. There may be other methods equally (or more) useful and trappers are encouraged to use whatever method seems most effective for the given situation.

When there is a need to avoid river otter while beaver trapping, consider the following suggestions:

- Stay alert for the presence of river otter sign on your trap line.
- Be cautious about using trap sets at high probability river otter travel-ways, particularly dam crossings, inlets and outlets to ponds/lakes, narrow streams and ditches that connect to other water bodies, crossover trails along shorelines, dikes and culverts and the entrances to inactive beaver bank dens or lodges.
- Use baited beaver sets where possible.
- Avoid using beaver lures that may also attract river otters to the set.
- Consider using a "side-parallel" position (Figure BV2) for the trigger wires on beaver bodygrip traps. Also consider the use of tension-adjustable triggers, or two-way triggers (those that don't spring when pushed sideways).
- Offset the trigger to one side on a bodygrip trap and place a stick in the mud directly in front of the trigger (make sure the stick is outside the closing radius of the trap). River otter will typically swim around the stick and avoid the trigger.
- Use castor mound sets with foothold traps set 8 to 10 inches deep for hind foot catches on beaver (to avoid river otter).

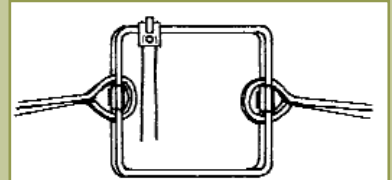

Figure BV2: Moving the trigger to one side of a bodygrip trap should decrease the likelihood of capturing a river otter.

- When using cable devices, use a 9 to 10 inch loop. Add loop “stops” to prevent the loop from closing tighter than a four inch diameter. At the water’s edge or on land, particularly if not using stops, place the bottom of the loop close to the ground. Also consider positioning the lock farther back from top-center to decrease the sensitivity of the device. Do not “load” snares; this will further reduce sensitivity.
- Gang-set active beaver areas (set an equal number of traps for the anticipated number of beavers). Catch beaver as fast as possible, and remove traps. Avoid leaving traps set for extended periods trying to catch the last beaver.
- When trapping under ice, make baited sets between active lodges/dams and food caches/piles.
- Carry a catchpole or other device to assist with releasing live-restrained river otter.
- For more information on river otter avoidance and proper trigger configurations to use for bodygrip traps to capture beaver, see the *Trapper Education Student Manual: A Guide for Trappers in the United States* published by the Association of Fish and Wildlife Agencies at http://www.fishwildlife.org/furbearer_resources.html
- Always check your state’s trapping regulations for guidance, specific restrictions or prohibitions related to river otter take while beaver trapping.



General Overview of Traps Meeting BMP Criteria for Beavers in the United States

Four basic types of traps were tested for beaver: foothold traps, cage traps, bodygrip traps and non-powered cable devices. Examples, brief descriptions, and mechanical details of the various devices are given in the next section.

Table BV1. Overview of traps meeting BMP criteria** for beavers in the United States.

Trap Category (recommended use)	Jaw/Frame Characteristics	Inside Jaw/Frame Spread at Dog*	Inside Width at Jaw/Frame Hinge Posts*	
Coil-spring (submersion only)	Unmodified	5 - 7 1/4	5 - 7 3/4	
Longspring (submersion only)	Unmodified	3 7/8	3 7/16	
	Double jaw	3 7/8	3 7/16	
	Dimensions*: Length X Width X Height	Mesh Size*/Gauge		
"Suitcase" Type Cage (live restraint or submersion)	39 x 43	2 x 2 16 gauge galvanized		
	Height of Trap Window*	Width of Trap Window*	Frame Wire*	Spring Wire*
†Bodygrip (on land or submersion)	6 7/8 - 11	7 - 12	1/4 - 5/16	1/4 - 5/16
	Cable Characteristics	Loop Diameter*	Lock Type	
Non-Powered Cable Devices (live restraint or submersion/under ice)	3/32" diameter 7 x 7 and 1 x 19 weave	9 - 10	relaxing	
	1/8" diameter 7 x 7 weave		relaxing	
	(For use in submersion/under ice sets only) 1/16" diameter 1 x 19 weave		relaxing or non-relaxing	

* Inches

**Any size foothold traps or bodygrip traps with these or larger measurements, which are commonly used for beavers, also meet BMP criteria for use in submersion sets for this species; foothold sizes commonly designated as 11, 1.5, 1.65, 1.75, 2, 3, 4, 5, and bodygrip sizes commonly designated as 220, 280, 330, and 440. Cable devices and cage traps with the above or similar measurements are also approved for use in submersion sets.

†All bodygrip traps tested had two springs.



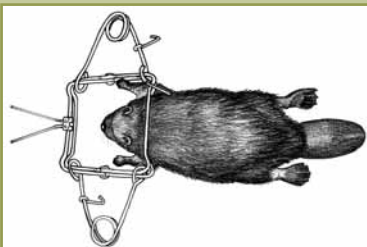

Figure BV3. Bodygrip proper strike location



Figure BV4a. Setting tool

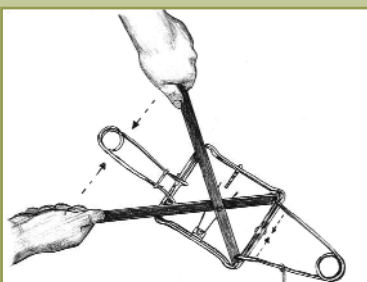

Figure BV4b. Using setting tool



Figure BV5a. Safety gripper



Figure BV5b. Using safety gripper

General Considerations When Trapping Beavers

Foothold (coil-spring and longspring) Traps (for submersion sets only)

- Many currently-used trap models meet specifications
- Can be used to capture several furbearer species

Cage or "Suitcase" Type Cage Traps

- Allow for use in locations and in weather conditions where other traps are less effective
- Capture and hold animals alive, allowing for release, or may be used in submersion sets
- Are large, cumbersome and expensive

Bodygrip Traps

- Should be placed so that the rotating jaws close on the top and bottom of the captured animal's neck (Figure BV3)
- Trigger configurations can be modified for species selective capture
- Allow for use in locations and in weather conditions where other traps are less effective
- May not be appropriate in some areas as land sets (captures and kills animals, no release)
- May require trigger replacements after several captures

Non-Powered Cable Devices

- Cables require frequent replacement
- Capture and hold animals alive, allowing for release, or may be used in submersion/under ice sets

Safe Use of Bodygrip Traps

By design, bodygrip traps must close with considerable force to humanely dispatch and efficiently capture wild furbearers. This is particularly true of larger sized and "magnum" type bodygrip traps. As a result, users should take special precautions to avoid potential injury when using these devices. Trappers should be familiar with the safe and efficient use of bodygrip traps and these are best learned in trapper education courses.

A setting tool (Figure BV4a) should be used to compress trap springs when setting large and magnum bodygrip traps. Use of a setting tool will not only make setting traps easier, it will make setting traps safer by allowing the trapper to keep hands and fingers away from the jaws (Figure BV4b). Most bodygrip traps that have double springs are equipped with spring latches that hold each spring compressed, and the trapper should use these latches on both trap springs. A safety gripper (Figure BV5a) should also be attached to the jaws when the jaws are moved to the set position (Figure BV5b). This will prevent the trap from accidentally closing. The above safety devices protect the trapper and make it easier to set, position and anchor the trap safely. Safety devices should be disengaged only when the set is completed.

If you are accidentally caught in a bodygrip trap you need to know how to free yourself. A setting tool is the most effective means to freeing yourself and should be used to compress the springs or jaws. You should always have one in reach when setting and placing bodygrip traps. In the event you are not able to reach one or use it with one arm, you should always carry a four foot piece of rope. The rope should have a loop tied on one end and should be stored in a pocket that can be easily accessed by either hand. You can use the rope to free yourself as follows:

- 1) Thread the rope through the eyes of one of the springs (Figure BV6a).
- 2) Bring the rope around and thread it back through the eyes a second time (Figure BV6b).
- 3) Place your foot in the looped end of the rope and pull the other end with your free hand until you can set the safety latch for that spring. (Figure BV6c).
You may need to do this to both springs to completely free yourself.

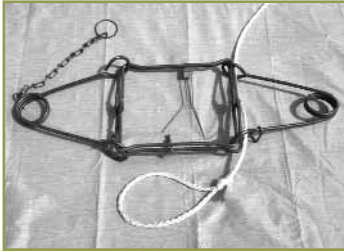

Figure BV6a. Step 1

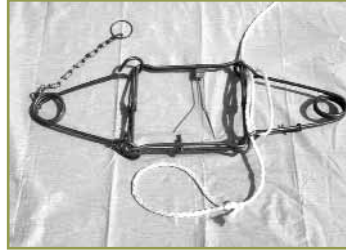

Figure BV6b. Step 2



Figure BV6c. Step 3

Specifications of Traps Meeting BMP Criteria for Beavers in the United States

As more capture devices are tested and new information becomes available, the list of devices will be updated. Mechanical descriptions of traps are given as an aid to trappers or manufacturers who may wish to measure, build or modify traps to meet these specifications (Figures BV7a and BV7b). Also, other commercially available traps, modified traps, or other capture devices not yet tested may perform as well as, or better than the listed BMP traps. References to trap names are provided to identify the specific traps tested. This list is provided for information purposes only and does not imply an endorsement of any manufacturer.

Average mechanical measurements are rounded to the nearest $\frac{1}{16}$ inch. There may be up to a $\frac{1}{8}$ inch variation in specifications on the part of the manufacturer. Manufacturers use recognizable names, such as "No. 2" coil-spring, to identify certain traps. However, there is no standardized system linking mechanical design features with trap names. The mechanical features of these traps are listed so that similar traps may be identified. The performance of anchoring systems was not specifically evaluated, however, methods of attachment are described for informational purposes.

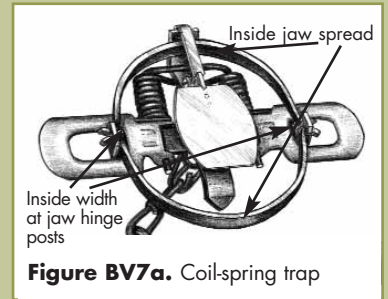

Figure BV7a. Coil-spring trap

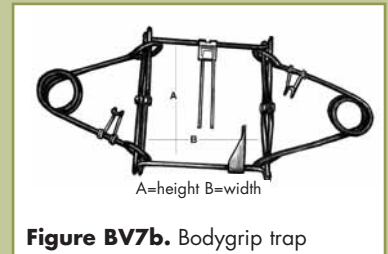

Figure BV7b. Bodygrip trap

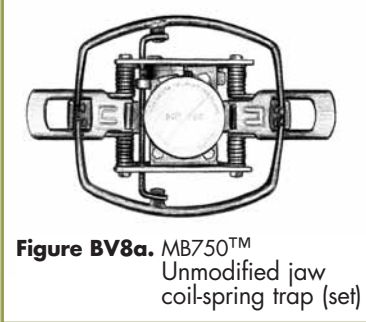

Figure BV8a. MB750™
Unmodified jaw
coil-spring trap (set)

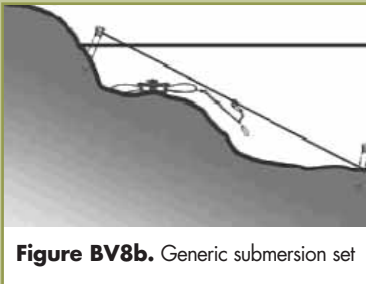

Figure BV8b. Generic submersion set

Submersion sets:

See the *Trapper Education Student Manual: A Guide for Trappers in the United States* at http://www.fishwildlife.org/furbearer_resources.html for more information on submersion sets.

Foothold Traps

Unmodified Jaw (Figures BV8a, BV8b and BV8c)

Average Mechanical Description and Attributes

Inside jaw spread (at dog): 7 1/4 inches

Inner width: 7 1/4 inches

Inside width at jaw hinge posts: 7 3/4 inches

Jaw width: 7/16 inch

Jaw thickness: 3/16 inch

Main trap springs: Four 0.160 inch diameter wire coil-springs

Base plate: Reinforced with D-ring

Any trap that has similar specifications may be considered a BMP trap regardless of brand or source of modification, although performance information on all other BMP criteria (see Introduction: "Criteria for Evaluation of Trapping Devices" pages 4-6) needs to be considered as well. The trap tested was the Minnesota Brand MB750™ coil-spring trap.

Additional Information

- For use in submersion sets only.
- Chain attachment used in trap testing: 30 inch center-mounted with three swivels, one in-line shock spring, and anchored with a stake. When using submersion sets (Figure BV8b), chain length should be short enough to prevent captured animals from resurfacing.
- Selectivity features: Brass pan tension machine screw; pan tension was set so two to four pounds of pressure triggered the trap, and was checked and readjusted as needed after every capture.



Average Mechanical Description and Attributes

Inside jaw spread (at dog): 5 inches

Inner width: 4 1/2 inches

Inside width at jaw hinge posts: 5 inches

Jaw width: 1/2 inch smooth round jaw

Jaw thickness: 1/8 inch

Main trap springs: Two 0.145 inch diameter wire coil-springs

Base plate: Not reinforced

Any trap that has similar specifications may be considered a BMP trap regardless of brand or source of modification, although performance information on all other BMP criteria (see Introduction: "Criteria for Evaluation of Trapping Devices" pages 4-6) needs to be considered as well. The trap tested was the Woodstream™ Victor No. 2 coil-spring.

Additional Information

- For use in submersion sets only.
- Chain attachment used in trap testing: 12 inch center-mounted with three swivels, one in-line shock spring, and anchored with a stake. When using submersion sets, chain length should be short enough to prevent captured animals from resurfacing.

- Selectivity features: Brass pan tension machine screw; pan tension was set so two to four pounds of pressure triggered the trap, and was checked and readjusted as needed after every capture.
- Special considerations for practicality: This device also meets BMP criteria for river otter (live restraint or submersion), mink, muskrat and nutria in submersion sets, and Eastern coyotes.



Average Mechanical Description and Attributes

- Inside jaw spread (at dog): 3 ⁷/₈ inches
- Inner width: 3 ¹/₈ inches
- Inside width at jaw hinge posts: 3 ⁷/₁₆ inches
- Jaw width: ¹/₂ inch
- Jaw thickness: ¹/₈ inch
- Length of main trap springs: 4 ³/₈ inches
- Thickness of main trap springs: ¹/₁₆ inch
- Width of main trap springs: 1 ¹/₂ inches narrowing to ⁵/₈ inch
- Base plate: Not reinforced
- Pan stop: Yes

Any trap that has similar specifications may be considered a BMP trap regardless of brand or source of modification, although performance information on all other BMP criteria (see Introduction: "Criteria for Evaluation of Trapping Devices" pages 4-6) needs to be considered as well. The trap tested was the Sleepy Creek™ No. 11 double-longspring trap.

Additional Information

- For use in submersion sets only.
- Chain attachment used in trap testing: 12 inch center-mounted with three swivels, one in-line shock spring, and anchored with a stake. When using submersion sets, chain length should be short enough to prevent captured animals from resurfacing.
- Selectivity features: Brass pan tension machine screw; pan tension was set so two to four pounds of pressure triggered the trap, and was checked and readjusted as needed after every capture.
- Special considerations for practicality: This device also meets BMP criteria for river otter, mink, muskrat and nutria in submersion sets.

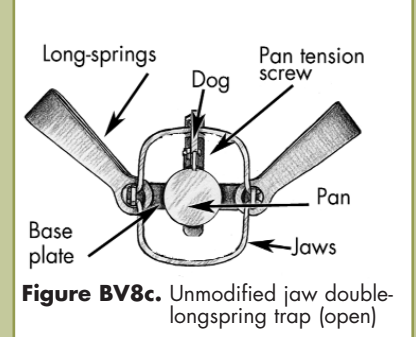

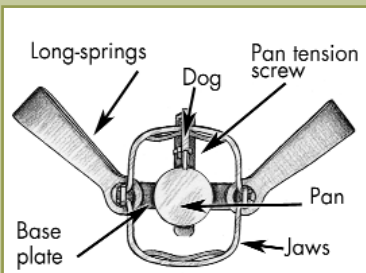

Figure BV9. Double jaw double-longspring trap (open)

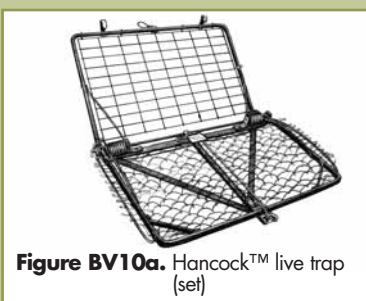

Figure BV10a. Hancock™ live trap (set)



Figure BV10b. Hancock™ live trap (closed)

Double Jaw (Figure BV9)

Average Mechanical Description and Attributes

Inside jaw spread (at dog): 3 ⁷/₈ inches

Inner width: 3 ¹/₈ inches

Inside width at jaw hinge posts: 3 ⁷/₁₆ inches

Jaw width: ¹/₂ inch

Jaw thickness: ¹/₈ inch

Length of main trap springs: 4 ³/₈ inches

Thickness of main trap springs: ¹/₁₆ inch

Width of main trap springs: 1 ¹/₂ inches narrowing to ⁵/₈ inch

Base plate: Not reinforced

Pan stop: Yes

Any trap that has similar specifications may be considered a BMP trap regardless of brand or source of modification, although performance information on all other BMP criteria (see Introduction: "Criteria for Evaluation of Trapping Devices" pages 4-6) needs to be considered as well. The trap tested was the Sleepy Creek™ No. 11 double-longspring trap with double-jaws.

Additional Information

- For use in submersion sets only.
- Chain attachment used in trap testing: 12 to 18 inch center-mounted with three swivels, one in-line shock spring, and anchored with a stake. When using submersion sets, chain length should be short enough to prevent captured animals from resurfacing.
- Selectivity features: Brass pan tension machine screw; pan tension was set so two to four pounds of pressure triggered the trap, and was checked and readjusted as needed after every capture.
- Special considerations for practicality: This device also meets BMP criteria for river otter (live restraint or submersion), mink, muskrat and nutria in submersion sets.



"Suitcase" Type Cage Traps (Figures BV10a and BV10b)

Average Mechanical Description and Attributes

Length open or closed: 39 inches

Width closed: 21 ¹/₂ inches

Width open: 43 inches

Mesh size: 2 x 2 inch, 16 gauge galvanized

Weight: 33 pounds

Any trap that has similar specifications may be considered a BMP trap regardless of brand or source of modification, although performance information on all other BMP criteria (see Introduction: "Criteria for Evaluation of Trapping Devices" pages 4-6) needs to be considered as well. The trap tested was the Hancock™ Live Trap.

Additional Information

- Anchoring: Traps should be securely wired at the vertical mesh to something solid such as a tree, culvert grate, re-rod stake, etc.
- Safety considerations: Users should follow manufacturer's safety precautions.
- Special considerations for practicality: Traps are large, cumbersome and expensive. May require repair after capture.



Bodygrip Traps (Figures BV11 and BV12)

Average Mechanical Description and Attributes

Height of trap window: 8 ¹/₈ inches

Width of trap window: 8 ³/₁₆ inches

Diameter of frame wire: ¹/₄ inch

Diameter of spring wire: ¹/₄ inch

Additional clamping bar: None, but does have a magnum bend which eliminates the gap between the jaws when the trap is closed.

Safety features: Safety latches on springs

Any trap that has similar specifications may be considered a BMP trap regardless of brand or source of modification, although performance information on all other BMP criteria (see Introduction: "Criteria for Evaluation of Trapping Devices" pages 4-6) needs to be considered as well. The trap tested was the Belisle™ Super X 280 bodygrip trap.

Additional Information

- Selectivity features: Species selective trigger configurations may improve selectivity.
- Safety considerations: This trap has complete jaw closure. The use of safety devices such as setting tongs and a safety gripper is highly recommended, and trappers should familiarize themselves with emergency release methods discussed in the "Safe Use of Bodygrip Traps" section.
- Special considerations for practicality: This device also meets BMP criteria for submersion sets for river otter.



Average Mechanical Description and Attributes

Height of trap window: 10 inches

Width of trap window: 10 inches

Diameter of frame wire: ⁵/₁₆ inch

Diameter of spring wire: ⁵/₁₆ inch

Additional clamping bar: None

Safety features: Safety latches on springs

Any trap that has similar specifications may be considered a BMP trap regardless of brand or source of modification, although performance information on all other BMP criteria (see Introduction: "Criteria for Evaluation of Trapping Devices" pages 4-6) needs to be considered as well. The trap tested was the Belisle™ Classic 330 bodygrip trap.

Additional Information

- Selectivity features: Species selective trigger configurations may improve selectivity.
- Safety considerations: Use of setting tongs and safety gripper is recommended.
- Special considerations for practicality: This device also meets BMP criteria for submersion sets for river otter.



Most bodygrip traps approved in this BMP were tested via computer simulation modeling relative to animal welfare performance. As a result, trap anchoring information does not exist for these traps. However, bodygrip traps should always be securely anchored. Anchoring information is provided on specific traps that were field tested.

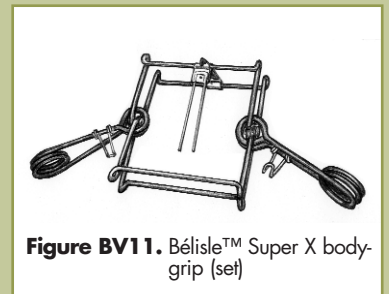

Figure BV11. Belisle™ Super X bodygrip (set)

Average Mechanical Description and Attributes

Height of trap window: 10 ¹/₈ inches

Width of trap window: 10 ⁷/₁₆ inches

Diameter of frame wire: ⁵/₁₆ inch

Diameter of spring wire: ⁵/₁₆ inch

Additional clamping bar: None, but does have a magnum bend which eliminates the gap between the jaws when the trap is closed

Safety features: Safety latches on springs

Any trap that has similar specifications may be considered a BMP trap regardless of brand or source of modification, although performance information on all other BMP criteria (see Introduction: "Criteria for Evaluation of Trapping Devices" pages 4-6) needs to be considered as well. The trap tested was the Belisle™ Super X 330 body-grip trap.

Additional Information

- Selectivity features: Species selective trigger configurations may improve selectivity.
- Safety considerations: This trap has complete jaw closure. The use of safety devices such as setting tongs and a safety gripper is highly recommended, and trappers should familiarize themselves with emergency release methods discussed in the "Safe Use of Bodygrip Traps" section.
- Special considerations for practicality: This device also meets BMP criteria for submersion sets for river otter.



Average Mechanical Description and Attributes

Height of trap window: 8 ³/₈ inches

Width of trap window: 8 ³/₈ inches

Diameter of frame wire: ¹/₄ inch

Diameter of spring wire: ¹/₄ inch

Additional clamping bar: None

Safety features: Safety latches on springs

Any trap that has similar specifications may be considered a BMP trap regardless of brand or source of modification, although performance information on all other BMP criteria (see Introduction: "Criteria for Evaluation of Trapping Devices" pages 4-6) needs to be considered as well. The trap tested was the BMI™ 280 bodygrip trap.

Additional Information

- Selectivity features: Species selective trigger configurations may improve selectivity.
- Safety considerations: Use of setting tongs and safety gripper is recommended.
- Special considerations for practicality: This device also meets BMP criteria for river otter in submersion sets.



Average Mechanical Description and Attributes

Height of trap window: 9 3/4 inches
Width of trap window: 10 3/8 inches
Diameter of frame wire: 5/16 inch
Diameter of spring wire: 5/16 inch
Additional clamping bar: None
Safety features: Safety latches on springs

Any trap that has similar specifications may be considered a BMP trap regardless of brand or source of modification, although performance information on all other BMP criteria (see Introduction: "Criteria for Evaluation of Trapping Devices" pages 4-6) needs to be considered as well. The trap tested was the BMI™ 330 bodygrip trap.

Additional Information

- Selectivity features: Species selective trigger configurations may improve selectivity.
- Safety considerations: Use of setting tongs and safety gripper is recommended.
- Special considerations for practicality: This device also meets BMP criteria for river otter in submersion sets.



Average Mechanical Description and Attributes

Height of trap window: 8 3/4 inches
Width of trap window: 10 1/2 inches
Diameter of frame wire: 5/16 inch
Diameter of spring wire: 5/16 inch
Additional clamping bar: None
Safety features: Safety latches on springs

Any trap that has similar specifications may be considered a BMP trap regardless of brand or source of modification, although performance information on all other BMP criteria (see Introduction: "Criteria for Evaluation of Trapping Devices" pages 4-6) needs to be considered as well. The trap tested was the Bridger™ 330 bodygrip trap.

Additional Information

- Selectivity features: Species selective trigger configurations may improve selectivity.
- Safety considerations: Use of setting tongs and safety gripper is recommended.
- Special considerations for practicality: This device also meets BMP criteria for river otter in submersion sets.



Average Mechanical Description and Attributes

Height of trap window: 8 ³/₈ inches

Width of trap window: 10 ¹/₂ inches

Diameter of frame wire: ⁵/₁₆ inch

Diameter of spring wire: ⁵/₁₆ inch

Additional clamping bar: None

Safety features: Safety latches on springs

Any trap that has similar specifications may be considered a BMP trap regardless of brand or source of modification, although performance information on all other BMP criteria (see Introduction: "Criteria for Evaluation of Trapping Devices" pages 4-6) needs to be considered as well. The trap tested was the Duke™ 330 bodygrip trap.

Additional Information

- Selectivity features: Species selective trigger configurations may improve selectivity.
- Safety considerations: Use of setting tongs and safety gripper is recommended.
- Special considerations for practicality: This device also meets BMP criteria for river otter in submersion sets.



Average Mechanical Description and Attributes

Height of trap window: 8 ³/₁₆ inches

Width of trap window: 8 ⁹/₁₆ inches

Diameter of frame wire: ¹/₄ inch

Diameter of spring wire: ¹/₄ inch

Additional clamping bar: None

Safety features: Safety latches on springs

Any trap that has similar specifications may be considered a BMP trap regardless of brand or source of modification, although performance information on all other BMP criteria (see Introduction: "Criteria for Evaluation of Trapping Devices" pages 4-6) needs to be considered as well. The trap tested was the LDL™ C280.

Additional Information

- Selectivity features: Species selective trigger configurations may improve selectivity.
- Safety considerations: This trap has complete jaw closure. The use of safety devices such as setting tongs and a safety gripper is highly recommended, and trappers should familiarize themselves with emergency release methods discussed in the "Safe Use of Bodygrip Traps" section.
- Special considerations for practicality: This device also meets BMP criteria for river otter in submersion sets.



Average Mechanical Description and Attributes

Height of trap window: 8 3/16 inches
Width of trap window: 8 9/16 inches
Diameter of frame wire: 1/4 inch
Diameter of spring wire: 1/4 inch
Additional clamping bar: Yes
Safety features: Safety latches on springs

Any trap that has similar specifications may be considered a BMP trap regardless of brand or source of modification, although performance information on all other BMP criteria (see "Criteria for Evaluation of Trapping Devices": Introduction pages 4-6) needs to be considered as well. The trap tested was the LDL™ C280 Magnum.

Additional Information

- Selectivity features: Species selective trigger configurations may improve selectivity.
- Safety considerations: This trap has complete jaw closure. The use of safety devices such as setting tongs and a safety gripper is highly recommended and trappers should familiarize themselves with the emergency release methods discussed in the "Safe Use of Bodygrip Traps" section.
- Special considerations for practicality: This device also meets BMP criteria for river otter in submersion sets.



Average Mechanical Description and Attributes

Height of trap window: 9 13/16 inches
Width of trap window: 10 3/8 inches
Diameter of frame wire: 5/16 inch
Diameter of spring wire: 5/16 inch
Additional clamping bar: Yes
Safety features: Safety latches on springs

Any trap that has similar specifications may be considered a BMP trap regardless of brand or source of modification, although performance information on all other BMP criteria (see "Criteria for Evaluation of Trapping Devices": Introduction pages 4-6) needs to be considered as well. The trap tested was the LDL™ C330 Magnum.

Additional Information

- Selectivity features: Species selective trigger configurations may improve selectivity.
- Safety considerations: This trap has complete jaw closure. The use of safety devices such as setting tongs and a safety gripper is highly recommended and trappers should familiarize themselves with the emergency release methods discussed in the "Safe Use of Bodygrip Traps" section.
- Special considerations for practicality: This device also meets BMP criteria for river otter in submersion sets.



Average Mechanical Description and Attributes

Height of trap window: 9 ¹³/₁₆ inches

Width of trap window: 10 ³/₈ inches

Diameter of frame wire: ⁵/₁₆ inch

Diameter of spring wire: ⁵/₁₆ inch

Additional clamping bar: None

Safety features: Safety latches on springs

Any trap that has similar specifications may be considered a BMP trap regardless of brand or source of modification, although performance information on all other BMP criteria (see Introduction: "Criteria for Evaluation of Trapping Devices" pages 4-6) needs to be considered as well. The trap tested was the LDL™ C330.

Additional Information

- Selectivity features: Species selective trigger configurations may improve selectivity.
- Safety considerations: This trap has complete jaw closure. The use of safety devices such as setting tongs and a safety gripper is highly recommended, and trappers should familiarize themselves with emergency release methods discussed in the "Safe Use of Bodygrip Traps" section.
- Special considerations for practicality: This device also meets BMP criteria for river otter in submersion sets.



Average Mechanical Description and Attributes

Height of trap window: 8 ¹/₈ inches

Width of trap window: 8 ¹/₈ inches

Diameter of frame wire: ⁵/₁₆ inch

Diameter of spring wire: ⁵/₁₆ inch

Additional clamping bar: None

Safety features: Safety latches on springs

Any trap that has similar specifications may be considered a BMP trap regardless of brand or source of modification, although performance information on all other BMP criteria (see Introduction: "Criteria for Evaluation of Trapping Devices" pages 4-6) needs to be considered as well. The trap tested was the Rudy™ 280.

Additional Information

- Selectivity features: Species selective trigger configurations may improve selectivity.
- Safety considerations: Use of setting tongs and safety gripper is recommended.
- Special considerations for practicality: This device also meets BMP criteria for river otter in submersion sets.



Average Mechanical Description and Attributes

Height of trap window: 10 1/4 inches
Width of trap window: 10 inches
Diameter of frame wire: 5/16 inch
Diameter of spring wire: 5/16 inch
Additional clamping bar: None
Safety features: Safety latches on springs

Any trap that has similar specifications may be considered a BMP trap regardless of brand or source of modification, although performance information on all other BMP criteria (see Introduction: "Criteria for Evaluation of Trapping Devices" pages 4-6) needs to be considered as well. The trap tested was the Rudy™ 330.

Additional Information

- Selectivity features: Species selective trigger configurations may improve selectivity.
- Safety considerations: Use of setting tongs and safety gripper is recommended.
- Special considerations for practicality: This device also meets BMP criteria for river otter in submersion sets.



Average Mechanical Description and Attributes

Height of trap window: 8 inches
Width of trap window: 8 inches
Diameter of frame wire: 5/16 inch
Diameter of spring wire: 1/4 inch
Additional clamping bar: Yes
Safety features: Safety latches on springs

Any trap that has similar specifications may be considered a BMP trap regardless of brand or source of modification, although performance information on all other BMP criteria (see Introduction: "Criteria for Evaluation of Trapping Devices" pages 4-6) needs to be considered as well. The trap tested was the Sauvageau™ 2001-8 bodygrip trap.

Additional Information

- Selectivity features: Species selective trigger configurations may improve selectivity.
- Safety considerations: This trap has complete jaw closure. The use of safety devices such as setting tongs and a safety gripper is highly recommended, and trappers should familiarize themselves with emergency release methods discussed in the "Safe Use of Bodygrip Traps" section.
- Special considerations for practicality: This device also meets BMP criteria for river otter in submersion sets.



Figure BV12. Sauvageau™ bodygrip trap with additional clamping bar (set)



Average Mechanical Description and Attributes

Height of trap window: 10 inches
Width of trap window: 9 inches
Diameter of frame wire: $\frac{5}{16}$ inch
Diameter of spring wire: $\frac{5}{16}$ inch
Additional clamping bar: Yes
Safety features: Safety latches on springs

Any trap that has similar specifications may be considered a BMP trap regardless of brand or source of modification, although performance information on all other BMP criteria (see Introduction: "Criteria for Evaluation of Trapping Devices" pages 4-6) needs to be considered as well. The trap tested was the Species Specific™ 330 Dislocator Half-Magnum bodygrip trap.

Additional Information

- Selectivity features: Species selective trigger configurations may improve selectivity.
- Safety considerations: This trap has complete jaw closure. The use of safety devices such as setting tongs and a safety gripper is highly recommended, and trappers should familiarize themselves with emergency release methods discussed in the "Safe Use of Bodygrip Traps" section.
- Special considerations for practicality: This device also meets BMP criteria for river otter in submersion sets.



Average Mechanical Description and Attributes

Height of trap window: $8 \frac{3}{8}$ inches
Width of trap window: $8 \frac{3}{8}$ inches
Diameter of frame wire: $\frac{1}{4}$ inch
Diameter of spring wire: $\frac{5}{16}$ inch
Additional clamping bar: None
Safety features: Safety latches on springs

Any trap that has similar specifications may be considered a BMP trap regardless of brand or source of modification, although performance information on all other BMP criteria (see Introduction: "Criteria for Evaluation of Trapping Devices" pages 4-6) needs to be considered as well. The trap tested was the Woodstream Oneida Victor 280 Conibear™ bodygrip trap.

Additional Information

- Anchoring: 18 inch chain anchored with a stake.
- Selectivity features: Species selective trigger configurations may improve selectivity.
- Safety considerations: Use of setting tongs and safety gripper is recommended.
- Special considerations for practicality: This device also meets BMP criteria for river otter in submersion sets.



Average Mechanical Description and Attributes

- Height of trap window: 9 3/4 inches
- Width of trap window: 10 3/8 inches
- Diameter of frame wire: 5/16 inch
- Diameter of spring wire: 5/16 inch
- Additional clamping bar: None
- Safety features: Safety latches on springs

Any trap that has similar specifications may be considered a BMP trap regardless of brand or source of modification, although performance information on all other BMP criteria (see Introduction: "Criteria for Evaluation of Trapping Devices" pages 4-6) needs to be considered as well. The trap tested was the Woodstream Oneida Victor 330 Conibear™ bodygrip trap.

Additional Information

- Anchoring: 18 inch chain anchored with a stake.
- Selectivity features: Species selective trigger configurations may improve selectivity.
- Safety considerations: Use of setting tongs and safety gripper is recommended.
- Special considerations for practicality: This trap also meets BMP criteria for river otter.



Bodygrip Traps (for submersion only)

Average Mechanical Description and Attributes

- Height of trap window: 6 7/8 inches
- Width of trap window: 7 inches
- Diameter of frame wire: 1/4 inch
- Diameter of spring wire: 1/4 inch
- Additional clamping bar: None
- Safety features: Safety latches on springs

Any trap that has similar specifications may be considered a BMP trap regardless of brand or source of modification, although performance information on all other BMP criteria (see Introduction: "Criteria for Evaluation of Trapping Devices" pages 4-6) needs to be considered as well. The trap tested was the Woodstream Oneida Victor 220 Conibear™ bodygrip trap.

Additional Information

- For use in submersion sets only.
- Chain attachment used in trap testing: 18 inch chain anchored with a stake.
- Selectivity features: Species selective trigger configurations may improve selectivity.
- Safety considerations: Use of setting tongs and safety gripper is recommended.
- Special considerations for practicality: This device also meets BMP criteria for river otter in submersion sets and raccoon.



Submersion sets:

See the Trapper Education Student Manual: *A Guide for Trappers in the United States* at http://www.fishwildlife.org/furbearer_resources.html for more information on submersion sets.



Average Mechanical Description and Attributes

Height of trap window: 9 inches
Width of trap window: 12 inches
Diameter of frame wire: $\frac{5}{16}$ inch
Diameter of spring wire: $\frac{5}{16}$ inch
Additional clamping bar: Yes
Safety features: Safety latches on springs

Any trap that has similar specifications may be considered a BMP trap regardless of brand or source of modification, although performance information on all other BMP criteria (see Introduction: "Criteria for Evaluation of Trapping Devices" pages 4-6) needs to be considered as well. The trap tested was the Species Specific™ 440 Dislocator Half-Magnum bodygrip trap.

Additional Information

- For use in submersion sets only.
- Selectivity features: Species selective trigger configurations may improve selectivity.
- Safety considerations: This trap has complete jaw closure. The use of safety devices such as setting tongs and a safety gripper is highly recommended, and trappers should familiarize themselves with emergency release methods discussed in the "Safe Use of Bodygrip Traps" section.
- Special considerations for practicality: This device also meets BMP criteria for river otter in submersion sets.



Average Mechanical Description and Attributes

Height of trap window: 11 inches
Width of trap window: 11 inches
Diameter of frame wire: $\frac{5}{16}$ inch
Diameter of spring wire: $\frac{5}{16}$ inch
Additional clamping bar: Yes
Safety features: Safety latches on springs

Any trap that has similar specifications may be considered a BMP trap regardless of brand or source of modification, although performance information on all other BMP criteria (see Introduction: "Criteria for Evaluation of Trapping Devices" pages 4-6) needs to be considered as well. The trap tested was the Sauvageau™ 2001-11 bodygrip trap.

Additional Information

- For use in submersion sets only.
- Selectivity features: Species selective trigger configurations may improve selectivity.
- Safety considerations: This trap has complete jaw closure. The use of safety devices such as setting tongs and a safety gripper is highly recommended, and trappers should familiarize themselves with emergency release methods discussed in the "Safe Use of Bodygrip Traps" section.
- Special considerations for practicality: This device also meets BMP criteria for river otter in submersion sets.



Average Mechanical Description and Attributes

- Height of trap window: 11 inches
- Width of trap window: 11 inches
- Diameter of frame wire: 5/16 inch
- Diameter of spring wire: 5/16 inch
- Additional clamping bar: None
- Safety features: Safety latches on springs

Any trap that has similar specifications may be considered a BMP trap regardless of brand or source of modification, although performance information on all other BMP criteria (see Introduction: "Criteria for Evaluation of Trapping Devices" pages 4-6) needs to be considered as well. The trap tested was the Sauvageau™ 1000-11F body-grip trap.

Additional Information

- For use in submersion sets only.
- Selectivity features: Species selective trigger configurations may improve selectivity.
- Safety considerations: Use of setting tongs and safety gripper is recommended.
- Special considerations for practicality: This device also meets BMP criteria for river otter in submersion sets.



Non-Powered Cable Devices (Figure BV13)

Average Mechanical Description and Attributes

- Cable diameter: 3/32 inch, 7 X 7 weave
- Cable length: 36 inch capture cable, 50 inch extension cable
- Cable lock: Relaxing
- Catch loop size: 9 – 10 inches

Any cable device that has similar specifications may be considered a BMP device regardless of brand or source of modification, although performance information on all other BMP criteria (see Introduction: "Criteria for Evaluation of Trapping Devices" pages 4-6) needs to be considered as well. Locks tested consisted of a reverse bend washer lock with an outside diameter of 1 1/4 inches.

Additional Information

- Anchoring was achieved by a 50 inch extension of 3/32 cable with two swivel points and anchored with a stake. One swivel was located between the capture cable and the extension, while the other swivel was located at the anchoring end of the extension.
- Selectivity Features: A 9 to 10 inch diameter loop was set resting on the ground perpendicular to the line of travel of an approaching beaver, and supported with a guide stick or wire (Figure BV14).
- Special Considerations for Practicality: Cables will typically need to be replaced after each capture. Minimally, the cable should be closely inspected for kinks or damage before reuse.

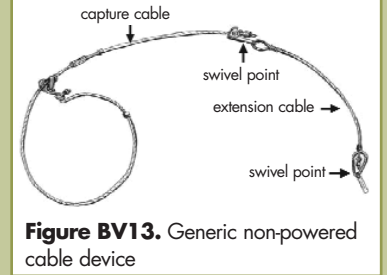

Figure BV13. Generic non-powered cable device

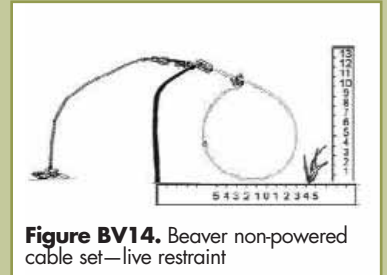

Figure BV14. Beaver non-powered cable set—live restraint



Average Mechanical Description and Attributes

Cable diameter: $\frac{3}{32}$ inch, 7 X 7 weave

Cable length: 42 inch capture cable, 44 inch extension cable

Cable lock: Relaxing

Catch loop size: 9 – 10 inches

Any cable device that has similar specifications may be considered a BMP device regardless of brand or source of modification, although performance information on all other BMP criteria (see Introduction: “Criteria for Evaluation of Trapping Devices” pages 4-6) needs to be considered as well. Lock consisted of a cam lock with no spring.

Additional Information

- Anchoring was achieved by a 44 inch extension of $\frac{3}{32}$ cable with two swivel points and anchored with a stake. One swivel was located between the capture cable and the extension, while the other swivel was located at the anchoring end of the extension.
- Selectivity Features: A 9 to 10 inch diameter loop was set resting on the ground perpendicular to the line of travel of an approaching beaver, and supported with a guide stick or wire (Figure BV14).
- Special Considerations for Practicality: Cables will typically need to be replaced after each capture. Minimally, the cable should be closely inspected for kinks or damage before reuse.



Average Mechanical Description and Attributes

Cable diameter: $\frac{3}{32}$ inch, 7 X 7 weave

Cable length: 42 inch capture cable, 44 inch extension cable

Cable lock: Relaxing

Catch loop size: 9 – 10 inches

Any cable device that has similar specifications may be considered a BMP device regardless of brand or source of modification, although performance information on all other BMP criteria (see Introduction: “Criteria for Evaluation of Trapping Devices” pages 4-6) needs to be considered as well. Lock consisted of the BMI Slide Free™ Lock.

Additional Information

- Anchoring was achieved by a 44 inch extension of $\frac{3}{32}$ cable with two swivel points anchored with a stake. One swivel was located between the capture cable and the extension, while the other swivel was located at the anchoring end of the extension.
- Selectivity Features: A 9 to 10 inch diameter loop was set resting on the ground perpendicular to the line of travel of an approaching beaver, and supported with a guide stick or wire (Figure BV14).
- Special Considerations for Practicality: Cables will typically need to be replaced after each capture. Minimally, the cable should be closely inspected for kinks or damage before reuse.



Average Mechanical Description and Attributes

Cable diameter: 1/8 inch, 7 X 7 weave
Cable length: 42 inch capture cable, 44 inch extension cable
Cable lock: Relaxing
Catch loop size: 9 – 10 inches

Any cable device that has similar specifications may be considered a BMP device regardless of brand or source of modification, although performance information on all other BMP criteria (see Introduction: "Criteria for Evaluation of Trapping Devices" pages 4-6) needs to be considered as well. Lock consisted of a cam lock with no spring.

Additional Information

- Anchoring was achieved by a 44 inch extension of 3/32 cable with one swivel point and anchored with a stake. One swivel was located between the capture cable and the extension.
- Selectivity Features: A 9 to 10 inch diameter loop was set resting on the ground perpendicular to the line of travel of an approaching beaver, and supported with a guide stick or wire (Figure BV14).
- Special Considerations for Practicality: Cables will typically need to be replaced after each capture. Minimally, the cable should be closely inspected for kinks or damage before reuse.



Average Mechanical Description and Attributes

Cable diameter: 3/32 inch, 1 X 19 weave
Cable length: 72 inch capture cable
Cable lock: Relaxing
Catch loop size: 9 – 10 inches

Any cable device that has similar specifications may be considered a BMP device regardless of brand or source of modification, although performance information on all other BMP criteria (see Introduction: "Criteria for Evaluation of Trapping Devices" pages 4-6) needs to be considered as well. Lock consisted of Raymond Thompson Co. standard neck lock.

Additional Information

- Anchoring was achieved with a stake.
- Selectivity Features: A 9 to 10 inch diameter loop was set resting on the ground perpendicular to the line of travel of an approaching beaver, and supported with a guide stick or wire (Figure BV14).
- Special Considerations for Practicality: Cables will typically need to be replaced after each capture. Minimally, the cable should be closely inspected for kinks or damage before reuse.



Submersion sets:

See the *Trapper Education Student Manual: A Guide for Trappers in the United States* at http://www.fishwildlife.org/furbearer_resources.html for more information on submersion sets.

Non-Powered Cable Devices (for submersion only)*Average Mechanical Description and Attributes*

Cable diameter: $\frac{1}{16}$ inch, 1 X 19 weave

Cable length: 48 inch capture cable

Cable lock: Relaxing

Catch loop size: 9 – 10 inches

Any cable device that has similar specifications may be considered a BMP device regardless of brand or source of modification, although performance information on all other BMP criteria (see Introduction: "Criteria for Evaluation of Trapping Devices" pages 4-6) needs to be considered as well. Lock consisted of the BMI Slide Free™ Lock.

Additional Information

- This device was tested "under ice" and is recommended for use in submersion/under ice sets only.
- Anchoring was achieved by securing cable to a stabilizing pole.
- Selectivity Features: Loop size may affect selectivity.
- Special Considerations for Practicality: Cables will typically need to be replaced after each capture. Minimally, the cable should be closely inspected for kinks or damage before reuse.