

Trapper Education Manual



A GUIDE FOR TRAPPERS IN THE UNITED STATES

SAFETY – ANIMAL WELFARE – RESPONSIBILITY – FURBEARER CONSERVATION

Acknowledgements

Funding for trapper education student manual and related materials was provided by the U.S. Fish and Wildlife Service and the International Association of Fish and Wildlife Agencies (IAFWA) through a Pittman-Robertson Wildlife Restoration Multi-state Grant. The copyright is held by the IAFWA. Materials for print developed under the grant are free for use by state, provincial, and territorial fish and wildlife agencies. Images used in the manual come from many sources including public domain collections, state and federal agencies, and private companies. Most of the images require separate licensing for use in other types of publications.

Hundreds of individuals have contributed to the development of the IAFWA Trapper Education Program. Most state and provincial wildlife agencies provided copies of their trapper education materials for review. Many agency personnel provided comments on materials, answered questions, ran pilot courses, or helped in other ways. Many trappers, including members of the National Trappers Association and the Fur Takers of America also contributed. Special thanks go to the Ohio Division of Wildlife, the Ohio State Trappers Association, Hal Sullivan, Pat Howard, and Doug Wilson.

Members of the steering committee spent many hours reviewing documents, attending meetings, and providing advice as the program developed over two years. Committee members include: Tom Decker, Vermont Fish and Wildlife Department; Steve Hall, Texas Parks and Wildlife Department; Susan Langlois, Massachusetts Division of Fisheries and Wildlife; Eric Nuse, International Hunter Education Association; John Organ, U.S. Fish and Wildlife Service; Judy Stokes, New Hampshire Fish and Game; and Rick Tischaeyer, Trapper Education Consultant, North Dakota.

Samara Trusso, Program Manager of the IAFWA, coordinated the development of the Trapper Education Program. The materials were developed through a contract with Silvertip Productions, Ltd. Jim Wentz of Silvertip served as the primary author of the documents.



A message from the Director of the North Carolina Wildlife Resources Commission

Dear North Carolina Trapper Education Participant:

Thank you for your interest in the North Carolina Wildlife Resources Commission's trapper education course. We welcome the opportunity to be your education partner in this course or other advanced trainings and workshop opportunities available through the North Carolina Hunter Education Program.

This manual is based on the best management practices developed through the Association of Fish and Wildlife Agencies (AFWA), including input from N.C. Wildlife Resources Commission staff and members of the North Carolina Trappers Association. It is designed to provide introductory skills and information through science-based furbearer trapping. Through trapper education, we can ensure that future generations will enjoy furbearer trapping opportunities in a responsible, sustainable and ethical manner.

We are confident that you will find the course to be rewarding and experiential. The Wildlife Commission shares your appreciation and concern for wildlife resources and is dedicated to supporting your wildlife-associated recreation pursuits. Together we can strengthen and improve the services we provide to you and work toward achieving our common goals.

A handwritten signature in black ink, appearing to read "Linda S. Myer".

Photo and Artwork Credits

CDC--Center For Disease Control; Eyewire.com; FWS – U.S. Fish and Wildlife Service; IAFWA; Joe Goodman, Artist, Courtesy of IAFWA; Natalene Cummings, Artist, Courtesy of IAFWA; Massachusetts Division of Fisheries and Wildlife; Conservation Commission of the State of Missouri; Ohio Division of Wildlife & Hal Sullivan; Silvertip Productions, Ltd. & Mary Wentz, Jim Wentz, Mike McNeese; Texas Parks and Wildlife Department & Steve Hall; USDA – United States Department of Agriculture; USGS - United States Geological Survey; Nielsen/Painet - Erwin C. Nielsen/Painet Inc.; Wisconsin Department of Natural Resources; Wyoming Game and Fish Department & Chris Madson

Copyright 2005 International Association of Fish and Wildlife Agencies

Trapper Education Manual

Table of Contents



Chapter 1 Introduction to Trapper Education	2-9
Chapter 2 Historical Considerations	10-17
Chapter 3 Furbearer Management	18-25
Chapter 4 Trapping Regulations	26-31
Chapter 5 Best Management Practices	32-25
Chapter 6 Traps	36-47
Chapter 7 Trapping Equipment	48-51
Chapter 8 Using Bait, Lure, and Urine	52-53
Chapter 9 Selective Trapping Techniques	54-57
Chapter 10 Water Sets	58-67
Chapter 11 Land Sets	68-77
Chapter 12 Cable Devices	78-85
Chapter 13 Trapping Safety	86-95
Chapter 14 Running a Trapline	96-101
Chapter 15 Using Furbearers	102-105
Chapter 16 Handling Fur	106-115
Chapter 17 Responsible Trapping	116-121
Chapter 18 Furbearers	122-135
Appendix A Traps, Sets, and Attractors	136-137
Appendix B Pelt Preparation	138-139
Glossary	Glossary

Chapter I

Introduction to Trapper Education



Ohio DOW Photo

Trapping benefits
Society

Trapping is highly regulated

Trapping is a highly engaging,
year-round activity

Content Standard - *Students demonstrate an understanding of the purpose of trapping and trapper education in today's society*

Introduction

Trapping is part of our North American heritage. First-time trappers in many states and Canadian provinces must complete a trapper education program covering skills, regulations, and trapping's role in scientific wildlife management. Trapper education programs teach basic techniques with a strong focus on the responsible treatment of animals, legal methods, safety, selectivity, and ethical trapper behavior.

This Trapper Education Program was developed by the International Association of Fish and Wildlife Agencies (IAFWA). The Association represents professionals from the fish and wildlife agencies of the states, provinces, and federal governments of the U.S. and Canada. The program was developed to:

- protect the health, safety, and welfare of people, wildlife, and domestic animals
- support wildlife conservation programs that sustain species and ecosystems for the benefit of future generations
- increase the benefits society currently receives from regulated trapping activities

Recognize that the decision to become a trapper represents a serious commitment of time and dedication to responsible behavior

Trapping is a highly regulated activity because the public is concerned about wildlife conservation and the welfare of wild animals. Regulations are designed to help manage furbearing animals using safe and selective equipment and techniques.

Safety - Animal Welfare - Responsibility - Furbearer Conservation



Trapping takes a lot of time and dedication. Trappers spend time studying wildlife, scouting, preparing traps, working with landowners, setting traps, running traplines, and preparing pelts. When trapping season starts, trappers must check the traps every day until they are removed.

Society, trappers and non-trappers alike, will not accept illegal or unethical behavior. This course can teach you the basics. You must be willing to spend the time and effort to trap responsibly.

List five positive or negative values of furbearers including ecological, biological, cultural, aesthetic, and economic values

Today fur products and trapping are still of cultural and economic importance. Furbearers continue to be used and managed as valuable, and renewable, natural resources.

Values associated with furbearers:

- Economic - Positive values includes furs, meat, and by-products such as perfume and fishing lures. Examples of negative values include crop depredation, property damage, and flooded roads.
- Ecological - Furbearers have positive value as predators and prey in functioning ecosystems. Excessive numbers of furbearers can have negative values if they harm habitats or prey on endangered animals.
- Cultural - Trapping is valued by many people as part of their cultural heritage. Trapping involves outdoor skills, knowledge and respect for wildlife, and family activities. Some people look to nature or the land to provide vegetables, firewood, venison, and furbearers. Trapping provides these people with needed food and clothing.
- Biological - Furbearers have positive values that help us understand human health and the effects of environmental pollutants. Negative biological values include human exposure to disease and parasites.
- Aesthetic - Furbearers have many positive aesthetic values for fur and wildlife watching.

Illegal or unethical behavior is not acceptable. Show respect for wildlife, people, and property



Ohio DOW Photo

Farmers who have crop damage will often give you permission to trap

Trapping is a way of life for many people



Silvertip Productions

Introduction to Trapper Education

Rabies and tularemia are two of the diseases humans may get from furbearers

Wetland habitats are home to hundreds of species of wildlife



FWS Photo

Whooping Crane

When voters restricted trapping in Massachusetts in 1996 landowner beaver complaints doubled

Trappers have helped restore river otter populations in 19 states - visit www.convservewildlife.org

A US Fish and Wildlife Service survey revealed 487 wildlife management programs that involved trapping on 281 National Wildlife Refuges



FWS Photo

List a minimum of four benefits regulated trapping provides to society

Responsible trappers provide these benefits to society:

- Disease Control - When trappers reduce local furbearer populations it helps reduce the spread of diseases among animals and people.
- Habitat Protection - When furbearers overpopulate they can destroy habitat. For example, the harvest of nutria in Louisiana helps protect 3.6 million acres of coastal wetlands.
- Endangered Species Protection - Foothold traps help protect many rare and endangered species from predators. Examples include the desert tortoise, sea turtles, whooping cranes, black-footed ferrets, and piping plovers.
- Property Protection - Farmers and other landowners benefit when trappers remove excess furbearers that threaten property and crops.
- Wildlife Restoration - Trappers use foothold traps to harmlessly capture species such as river otters in states where they are plentiful so they can be released in other states to re-establish populations.
- Wildlife Research - Foothold traps and cable devices are the only effective means for catching elusive species such as wolves, coyotes, and foxes. Wildlife biologists depend on traps and trappers to help study many species of wildlife.

Choose correctly that trapping is an individual privilege, not an individual right

In most states, trapping is an individual privilege available to all citizens who choose to follow regulations and behave responsibly. Trappers who violate laws can lose their privilege to trap. If trappers as a group do not behave responsibly, citizens could decide to stop all trapping.

Some states have made it a collective right to hunt, fish, and trap. This protects the activity of trapping for future generations. It does not protect trapping privileges for people who violate trapping regulations. Judges can, and do, suspend trapping privileges for serious violations.



Identify a minimum of two state or national trappers associations that provide materials and continuing education for trappers

Trappers have formed state and national organizations to help address issues related to trapping and furbearer management. Two national groups include the National Trappers Association and the Fur Takers of America.

The National Trappers Association (NTA) has the following purpose statement:

- To promote sound conservation, legislation, and administrative procedures;
- To save and faithfully defend from waste the natural resources of the United States;
- To promote sound environmental education programs; and
- To promote a continued annual fur harvest using the best tools presently available for that purpose.

The Fur Takers of America (FTA) has the following purpose:

- To promote interest in and accumulate and disseminate knowledge concerning the trapping of fur bearing animals among persons interested therein.

You can find out more about the NTA and FTA at their Web sites:

- <http://www.nationaltrappers.com/>
- <http://www.furtakersofamerica.com/>

The Web sites also link to state trapping associations, online bulletin boards, and other helpful organizations.

Write the name of your state trapping association here:

There are many benefits to membership in trapping organizations. You will learn new techniques to become more successful, be invited to meetings and other activities, gain a greater understanding of wildlife management, and learn about issues affecting trapping.

Organized trappers, hunters, and anglers have supported fish and wildlife conservation programs for more than 100 years

Membership in state and national trapping organizations will help you become a more successful and responsible trapper



FWS Photo

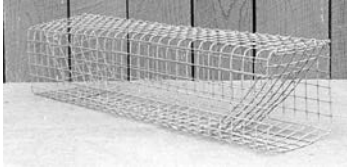
Arctic Fox

Online bulletin boards for trappers are a good way to learn new techniques and solve problems. Post a question, and get answers from friendly, experienced trappers.

Introduction to Trapper Education

In other chapters you will learn more about trap types and trapping techniques. Foothold traps, for instance, are live-restraining devices, but they can be used in "submersion" sets to kill aquatic furbearers

Submarine or Colony Trap trap for multiple muskrats



Ohio DOW Photo

Trapping technology and techniques have shown continuous improvement for nearly 200 years

Raccoons and coyotes are widely distributed in the U.S.

Know the legal types of traps that may be used in your state

Each state regulates the types of traps that are legal. States consider animal welfare, efficiency, selectivity, and safety when they select legal traps.

Deadfalls and many types of traps, including traps with teeth, are prohibited. Legal traps fall into two categories known as kill-type, and live-restraining devices. Put a check mark beside the traps that are legal to use in your state.

State: _____ Year: _____

Basic Trap Types	Legal
Foothold Traps	
Body-gripping Traps	
Cable Devices	
Cage traps	
Traps with teeth	
Deadfalls	
Other	

Name the species of furbearers that inhabit your state



Eyewire.com

Raccoon



FWS Photo

Coyote

The following species are known as furbearers in North America. Some of these species will not be present in your state. Even if a species is present there may be no open trapping season for it in your state.

Place a check in the box on the following chart to indicate if a species is present, and if there is an open trapping or hunting season for it in your state. Use your state hunting and trapping regulations brochure to find this information.

Safety - Animal Welfare - Responsibility - Furbearer Conservation



Species	Present	Open Season
Coyote		
Red Fox		
Gray Fox		
Gray Wolf		
Swift/Kit Fox		
Arctic Fox		
Beaver		
Muskrat		
Nutria		
Bobcat		
Canada Lynx		
Mink		
River Otter		
Fisher		
Marten		
Weasels		
Striped Skunk		
Badger		
Opossum		
Raccoon		
Ringtail - Bassarisk		
Wolverine		
Other:		

Even though a furbearer is present within your state, it may be restricted to specific habitats within a certain range

State wildlife agencies prohibit the taking of any species if it would harm the long-term sustainability of the population

Responsible trappers care about wildlife conservation and animal welfare



Nutria

FWS Photo



Gray Fox

FWS Photo

Nutria were introduced from South America. They are found in the gulf coast states, parts of the east coast, Washington and Oregon.

The gray fox is common in many parts of the country

Introduction to Trapper Education



FWS Photo

River Otter



Silvertip Productions

Opening Day

Know that the Trapper Education Course is based on Best Management Practices developed by wildlife biologists, trappers, and researchers

State fish and wildlife agencies, trapping organizations, veterinarians, and university researchers help develop Best Management Practices (BMPs) for regulated trapping in the United States.

Trapping BMPs are documents that provide information to help trappers practice safe, humane, and efficient techniques. BMPs describe different types of traps, how they work, how traps should be set, and what training may be needed for people who use BMP traps.

Five criteria are considered when developing BMPs:

- Animal welfare
- Trap efficiency
- Trap selectivity
- Trapper & public safety
- Practical application

BMPs provide guidance to wildlife agencies and help responsible trappers make decisions in the field.

Chapter 2

Historical Considerations



Content Standard - *Students use knowledge of history, public attitudes about wildlife, and the North American Model of Wildlife Conservation to understand regulated trapping as a legitimate activity*



FWS Photo

Fun to Know

Beaver felt hats were prized possessions among European men during the 1700's and early 1800s. They were expensive to make. The beaver were captured in North America and shipped a long distance to reach Europe. The manufacturing process was complex.



FWS Photo

Kit Fox

Students become aware of the fur trade's role in the exploration and settlement of North America

North America's fur trade began during the 1500s when Europeans explored the eastern coast. Native Americans gave the Europeans furs, deer hides, and meat in exchange for iron tools, wool blankets, colorful cloth, and guns. Samuel De Champlain, a French explorer, established the first North American fur trading post at Quebec in 1608.

The fur trade became North America's primary business. It was dominated by France until 1760. Numerous cities such as New York, Chicago, and St. Louis started as trading posts.

Many wars and battles were fought over the fur trade. During the 1600s, the Iroquois Nation frequently battled other native tribes in Canada and the Ohio Valley to gain control over land where furbearers lived. This period of time is known today as the Beaver Wars.

European nations also struggled for control of land and native trade. The Pilgrims at Plymouth issued licenses to regulate those who were permitted to trade furs with native people. The British gained control of the fur trade in 1760 after winning the French and Indian War. In 1816, the United States took control when Congress made it illegal for foreigners to trade in this country.

The fur trade declined over time, reaching a low about 1850. Habitat destruction and unregulated killing made furbearers scarce. Europeans were favoring silk over beaver felt, and Native American fur suppliers had declined due to disease, warfare, and displacement from their homelands.

During several centuries of fur trading, there was no effort to conserve wildlife or protect habitat. Everyone competed for the same wildlife resource. Beaver and otter were eliminated from much of the country. The govern-

Safety - Animal Welfare - Responsibility - Furbearer Conservation



ment did not regulate seasons or methods that could be used to take wildlife. Furbearers of all kinds were shot, speared, snared, or killed using deadfalls. Ponds were sometimes drained so all the beaver could be captured.

Widespread habitat destruction played a key role. During the early 1800s millions of acres of wetlands were drained, forests were cleared for farms, and prairies were plowed under. Streams and rivers ran heavy with silt, sewage, and industrial waste. In the East, nearly all species of fish and wildlife were in decline.

Steel traps did not play a major role in the development of the fur trade or the widespread declines of beaver, otters, and other furbearers. Steel traps were not mass produced or widely available until after 1823.

Students recognize that fish and wildlife resources are publicly owned, and managed according to society's laws, values, and attitudes

In North America wildlife is a public resource, owned by no individual. State and federal wildlife agencies manage wildlife for the benefit of all people. Public values and attitudes about wildlife determine how it can be used. Since the first European contact, people's attitudes about wildlife have changed.

People sometimes have conflicting attitudes about the way wildlife should be used or managed. The most serious conflicts are among people who have different views about killing wildlife. However, even people who hold similar views may disagree on how animals such as furbearers should be managed.

Attitudes and Values

The values people place on wildlife underlie their attitudes about when and how animals may be used. People who use wildlife for subsistence may revere animals even though they harvest wildlife for food and clothing. People who misuse or try to exterminate wildlife do not value animals at all until they are dead.

Conservationists place the highest values on preserving habitats, ecosystems, and sustainable wildlife populations. Conservationists accept regulated harvests of surplus animals as appropriate.

Strict protectionists value individual animals. They tend to oppose hunting and trapping out of concern for individual animals. Some protectionists have



Two kinds of beaver were used to make felt hats. At first, coat beaver were preferred. These were furs that had been worn by Native Americans until the guard hairs wore off.

Parchment beaver were prime pelts, but for a long time they had to be shipped to Russia for processing to remove the guard hairs. Eventually French and English hat makers discovered the Russian secrets and began to use parchment beaver for all their felt hats. The final blow to the early fur trade came when silk hats gained popularity in Europe.



Eyewire.com

Beaver

Great Hinckley Hunt, 1818

On December 24, 1818, 600 armed men encircled Hinckley Township in NE Ohio. They marched toward a central point and shot 300 deer, 21 bears, 17 wolves, plus hundreds of turkey, fox, and raccoons. This was an effort to exterminate all the wildlife.

Historical Considerations



FWS Photo

Grand Squirrel Hunt - Franklin Co., Ohio 1880 Newspaper Story

“The hunt was conducted agreeably to the instructions in our last paper. On counting the scalps it appeared that 19,660 scalps were produced. It is impossible to say what numbers in all were killed, as a great many of the hunters did not come in. We think we can safely challenge any other county in the State to kill squirrels with us.”

Market “Hunters”

Before wildlife was protected by seasons and bag limits, market “hunters” killed millions of animals a year to supply food to restaurants and grocery stores. Market “hunters” had a strict “utilitarian” attitude toward wildlife. They were not “hunters” according to today’s meaning of the word.

a mistaken belief that hunting and trapping will threaten the entire population.

Animal rights activists believe all animals have the same rights as humans. They oppose any human use of animals and may value an animal’s life as much as a human life.

Subsistence Attitude

Prior to European influence wildlife was a source of food, clothing, and tools for Native Americans. They had few crops to grow, and no livestock. The lives of plants and wild animals were spiritually and culturally connected to the lives of native peoples.

Later, pioneers such as Daniel Boone and Simon Kenton depended on wildlife as they opened up new territory for settlement. Today, only a few people totally depend on wildlife for subsistence.

Utilitarian Attitude

European settlers and Native Americans alike viewed wildlife as a common resource. No one owned wildlife until they killed it. Some people made their living by killing animals for fur, meat, or feathers. At the time there were no government agencies to manage and protect wildlife.

Extermination Attitude

When people started farming in the wilderness, wildlife became a nuisance. Bears, wolves, and mountain lions were a threat to people or livestock. Deer, raccoon, and squirrels damaged crops. Farmers shot wildlife, or paid others to do it. Government agencies paid bounties on many animals.

During the 1800’s former military officers sometimes organized “armies” to conduct “wars of extermination” on wild animals. Communities held events to see who could kill the most wildlife on a given day or weekend. Widespread events could result in tens of thousands of animals being killed in a single day.

Conservation Attitude

By the mid-1800s many people no longer depended on wildlife for survival. Some began to enjoy hunting, fishing, and camping as leisure activities. Habitat destruction, market hunting, and extermination efforts were reducing

Safety - Animal Welfare - Responsibility - Furbearer Conservation



animal populations. As wildlife became scarce, conservation became a concern for hunters. Conservationists wanted to save critical habitats and remaining populations of wildlife. There was no scientific knowledge about wildlife management. It took decades to create natural resource agencies and funding sources. Leaders such as President Theodore Roosevelt, a hunter, created public support for wildlife and a conservation ethic.

Today, wildlife conservation programs are based upon sustainable use. Individual animals may be used in accordance with laws, while habitats and animal populations are preserved. Many people, including hunters and trappers, are conservationists who care about wildlife while recognizing that regulated use is beneficial to society and the resource.

Preservation Attitude

Many people value wildlife but they fail to see the positive connection between hunting and trapping, and sustainable populations. Preservationists may oppose hunting and trapping in the belief it endangers animals. However, many preservationists are open-minded, and willing to examine facts about wildlife management.

Animal Rights Attitude

A small but highly vocal group of Americans believe in animal rights. The primary concern of Animal Rights advocates is the moral obligation of people. They believe animals have the same rights as humans and therefore oppose any human use of animals including hunting, trapping, farming practices, research on animals, rodeos, circuses, horse races, and other animal-related activities. Some animal rights proponents even oppose owning animals as pets.

Apathetic Attitude

A high percentage of the American public is growing up with little connection to the land. Few of these people think about wildlife on a daily basis, and most have no personal experience that would help shape their attitude. If they encounter wildlife doing damage to their property, they may want it exterminated or removed. If someone shows them pictures of animals in traps and claims it is cruel, they may oppose trapping or vote to make it illegal. An apathetic person's attitude can be easily changed, but they may not spend much time considering the issues.



FWS Photo

Sport Hunters

The term "sport hunter" arose in the United States during the mid-1800s to distinguish those who practiced "fair chase" hunting techniques from commercial "market hunters." Sport hunters placed limits on themselves and their hunting methods in order to test their skills and give animals a reasonable opportunity to escape. The code of the sportsman arose to define proper conduct for hunters.



Silvertip Productions

Historical Considerations

Some people oppose any use of animals, including human consumption of meat, fish, eggs, and milk.



Silvertip Productions

Meats



FWS Photo

Bobcat

Animal Welfare and Animal Rights

Most Americans, including those who trap, care about animal welfare. A small number of people hold animal rights beliefs. A person concerned with animal welfare wants to minimize pain and suffering when animals are trapped, or used any other way. A person who believes in animal rights believes animals have a right not to be trapped at all.

Most trappers are concerned with animal welfare. Those who are not are unlikely to be accepted by other trappers.

Wildlife agencies are concerned about sustainable long-term populations and individual animal welfare. Many trapping regulations are enacted to improve animal welfare. Agencies regulate types of traps that may be used, where they may be set, seasons, and how often traps must be checked. Trapper education programs play a role in animal welfare, too.

One of the most important efforts to improve animal welfare is known as the Best Management Practices project. The International Association of Fish and Wildlife Agencies has spent years working with wildlife agencies, trappers, veterinarians, universities, and other groups to develop Best Management Practices. This project is ongoing, and provides information used in this Trapper Education Manual.

Students identify key components of the North American Model of Wildlife Conservation

The United States and Canada have the most successful system of wildlife management the world has ever known. Conservationists, especially hunters and trappers, supported the development of The North American Model of Wildlife Conservation. This model is defined by seven principles:

Wildlife as a Public Trust Resource

Legally, wildlife is a public resource, held in trust by the government, and managed by fish and wildlife agencies. State wildlife agencies are responsible for most wildlife management and regulation. The U.S. Fish and Wildlife Service has authority over migratory birds and federally endangered species. The Service works cooperatively with the states and other nations.



Elimination of Markets for Wildlife

The elimination of commercial killing (market hunting) of most wildlife for meat, feathers, or other uses was critical in halting what would have been a “tragedy of the commons.” Furbearers are an exception. Using regulated trapping, furbearer populations will sustain a commercial market and provide significant benefits to society.

Allocation of Wildlife by Law

Public privileges to use wildlife and have a say in its management are guaranteed by law. Hunting and trapping privileges are not restricted to wealthy landowners or granted as special considerations. Individuals can lose their privileges if they violate laws pertaining to the legal harvest of wildlife.

Wildlife May Be Killed Only for a Legitimate Purpose

Killing wildlife for frivolous reasons is prohibited by law. If society is going to sanction the killing of wildlife it must be for a legitimate purpose such as using the animal or its parts for food, clothing, medicine, self-defense, or property protection.

Wildlife Is Considered an International Resource

The Migratory Bird Treaty of 1916 between the United States and Canada was the world’s first significant international treaty for the management of wildlife. Today, waterfowl, songbirds, and other migratory wildlife benefit from international management and regulation.

Science is the Proper Tool for Discharge of Wildlife Policy

Science has been the primary basis for wildlife restoration and management, and the formation of the wildlife profession. North Americans used wildlife science as a basis for managing wildlife decades ahead of everyone else in the world.

Democracy of Hunting and Trapping

In North America, everyone has the opportunity to participate in regulated hunting and trapping. President Theodore Roosevelt wrote about the societal gains to be made by keeping land available for hunting for all people. This is very different from a model that existed for centuries in Europe, where

Tragedy of the Commons

The “Tragedy of the Commons” relates to common resources that are available to all. In this situation, the greediest will gain the most, for a time. Restrictions on use of common resources are necessary to prevent overuse by individuals that could result in the loss of these resources to society.



Eyewire.com

Red Fox



FWS Photo

Muskrat

Historical Considerations

Furbearers are not considered to be migratory. State fish and wildlife agencies are responsible for managing furbearers.



Eyewire.com

Coyote



FWS Photo

Bobcat

wealthy people owned wildlife and the land, and only the wealthy could fish and hunt. In North America, wildlife is owned by the public, and responsible citizens have equal opportunities to participate in regulated hunting or trapping.

Hunters and trappers provide the funding for wildlife management programs and the purchase of critical habitats. When they join together with a common purpose, hunters and trappers are a political force speaking out in favor of wildlife conservation.

Thanks to conservation-minded hunters and trappers, species such as elk, deer, geese, wild turkeys, wood ducks, beaver, bald eagles, and river otters are more numerous today than they were in 1900. Hunters, trappers, and other conservationists were the first people to place a value on living wildlife. As a result, wildlife is now managed as a public resource to be conserved for the benefit of all.

Students use their knowledge of history, public attitudes about wildlife, and the North American Model of Wildlife Conservation to participate in discussions about regulated trapping and the role of trappers in today's society

Think about each of the people in the following scenarios and the attitudes they may have about furbearers and trapping. What would you do in this situation? If you could talk to the people, what would you say? What might change their feelings? If everyone in your community had the same attitudes about wildlife, what might happen as a result?

Scenario 1: *You stop at a roadside stand where a farmer sells fruits and vegetables. You overhear a customer say “Why is your sweet corn so expensive this year?” The farmer says “Raccoons have eaten nearly half my corn. I never saw so much damage.”*

Scenario 2: *Your family has trapped on several properties in your neighborhood for many years. One property with two large ponds was sold to a family from another state. A month before trapping season opens you stop by to introduce yourself. A young child waves at you as you pull in the drive. As you get out of the car you notice a bumper sticker on the car in front of you. It says “Real Men Don't Eat Meat.” The front door opens and a young man steps out to check on the child.*

Safety - Animal Welfare - Responsibility - Furbearer Conservation



Scenario 3: *You take your dog to the vet for annual shots. While you are waiting a woman rushes in crying and holding a badly injured cat. She tells the receptionist her cat is dying after being attacked by a coyote.*

Scenario 4: *You are sitting in a restaurant having lunch. You overhear a conversation at the table next to you. It sounds like the three men sitting there are poaching deer and selling the meat, but you aren't sure. Sometimes their talk sounds like it is in code. When you leave the restaurant there is a truck parked next to you. You see a spotlight on the seat. As you back out you notice blood and deer hair on the bumper.*



FWS Photo

River Otter

Chapter 3

Furbearer Management



Content Standard - *Students use knowledge of furbearer management principles, practices, and issues to explain current management programs in their state*

Introduction

Wildlife management is a science. Wildlife biologists are professionals. Biologists apply the basic principles of ecology to maintain and manage wildlife. Many biologists are as highly trained as physicians, lawyers, or college professors.

Some wildlife biologists specialize in the management of furbearers and their habitats. Furbearer biologists monitor animal populations, habitat, and diseases that may affect furbearers or cause human health problems. They develop management goals and create plans to meet those goals.

Furbearer biologists set regulations to protect or restore threatened and endangered species, allow for the harvest of surplus animals, or reduce overabundant furbearer populations. They also work to educate landowners and the general public. Without public education, it is difficult to have public support for management programs.

Few people truly understand wildlife management. Along with biologists, experienced trappers are among the people most knowledgeable about wildlife. This is because trappers must study wildlife and habitats to be successful.

As people learn more about wildlife, they usually care about it more. When caring leads to actions that conserve wildlife for future generations, the person has become a conservationist. This chapter will introduce you to the principles of furbearer management. Through further study and experience, you can develop the knowledge, skills, and attitudes to become a true conservationist.



FWS Photo

Biologist with wolf

Responsible trappers learn about wildlife and take action to conserve it for future generations



FWS Photo

Volunteer works on nest box at U.S. Fish and Wildlife Service Refuge



Identify the government agency with the authority to manage furbearer resources and regulate trapping in your state

State wildlife agencies have the authority and responsibility to manage furbearer resources and regulate trapping. Write the correct name of your state wildlife agency in the space below:

Explain the difference between a renewable and a non-renewable resource

Natural resources fall into one of two categories: renewable and non-renewable. Renewable resources are living things with the capacity to regenerate. Plants and animals are renewable resources. For example, when trees are cut down, new trees can grow there again from seeds. Similarly, when some wild animals are harvested by people or die due to disease, predation, or starvation, the remaining animals have young and the population increases again. Trees and animals are resources that can be renewed as long as the habitat is available.

Non-renewable resources are non-living items that are finite and do not regenerate themselves. Coal, oil and natural gas are examples of non-renewable resources.

Identify the components of habitat and name three types of habitats used by furbearers

Wildlife habitat is made up of food, water, cover, and space. Each species of wild animal needs certain kinds of food and cover. Each species also needs a certain amount of space, or habitat, to provide for its needs.

The quality and quantity of habitat in an area affects the number of species present, and the population level of each species.

Each species of wild animal is associated with a certain kind of habitat. Wetlands, forests, grasslands, and farms are common types of habitat used by furbearers.

Arrangement is an important characteristic of habitat. When habitat types are mixed, the area will generally support more species and higher populations of wildlife.

State agencies have the legislative authority to manage wildlife on behalf of the public



Silvertip Productions

Trees, like wildlife, are renewable



FWS Photos

Oil is a non-renewable resource



FWS Photo

Beaver lodge - habitat

Furbearer Management



FWS Photo

Biologist tracking wildlife



Silvertip Productions

Millions of Americans hunt and trap.

Identify two key concepts of sustainable management of wildlife resources

Native wildlife populations are natural resources - biological wealth - that must be sustained and managed for the benefit of present and future generations of people.

Wildlife biologists focus on protecting, preserving, and improving habitats and ecosystems. It is important to understand that biologists also focus on maintaining sustainable populations of wildlife, not individual animals.

Most species of wildlife, including furbearers, have short life spans. In the long term, individual animals do not endure, but populations do.

Sustainable management of furbearer populations depends upon these two key concepts:

- A focus on habitat
- A focus on the furbearer population

Name three principles that are applied in the harvest of wild animals in North America

Biologists generally look for three requirements before allowing the harvest of wild animals:

- The species is not threatened or endangered
- The harvest techniques are acceptable
- Killing the animals serves a practical purpose

Identify the major factors that affect wildlife populations

Furbearer populations change over time. Populations are highest after the young are born each year. Some animals die due to weather, food supplies, diseases, and predation, so the number of animals declines until more are born the following year. Animal populations also change over longer periods of time, usually due to changes in the quantity and quality of habitat.

Many wild animals, including furbearers, produce a lot of young. A few ani-



imals can quickly populate an area of suitable habitat. River otters provide one example. In many states river otters were extirpated long ago due to habitat destruction and unregulated killing. In recent years, some river otter habitat has been restored. Biologists and trappers captured river otters in states where the populations were high, and released a few in the restored areas. Within a short time, the otter populations expanded to fill the available habitat.

The number of animals a given area can support throughout the year is known as its biological carrying capacity. Limiting factors determine what the biological carrying capacity will be. Food is a common limiting factor. Water, shelter, space, disease, and predation are other types of limiting factors biologists must monitor.

Over the course of many years furbearer populations may decline a lot more than normal due to catastrophic events. Examples include habitat destruction such as forest fires, extreme weather such as blizzards, and diseases such as rabies. If a few animals survive, the population is capable of recovering when conditions return to normal. During these times, biologists may restrict harvest and take other actions to help the animals or the habitat.

Explain the difference between managing furbearers for compensatory mortality and additive mortality

Biologists consider several factors when setting management goals for each furbearer species. Two of these factors include the biological carrying capacity of the habitat, and the cultural carrying capacity. Biological carrying capacity refers to the number of animals the habitat can support. Cultural carrying capacity refers to the number of animals that society will accept, which may be a lower level than the biological carrying capacity.

Under normal conditions furbearers produce a surplus of young. Wildlife managers can set seasons, bag limits and trapping methods to allow part of the annual surplus to be harvested. Biologists manage for compensatory mortality by substituting regulated trapping for other mortality factors that would otherwise reduce the population. When managing for compensatory mortality, trapping does not affect the overall population that survives until spring. If trapping did not occur, a similar number of animals would be lost due to limiting factors, such as a lack of food or shelter. The population level is determined by the biological carrying capacity of the habitat.

While some furbearer populations can change dramatically, most populations become stable when their population reaches the biological carrying capacity. In some areas high furbearer populations can cause major problems. Beaver, for example, may flood farm fields and roads, or interfere with city water

Habitat destruction leads to long term declines in wildlife populations

Extirpated means that a species no longer exists in a range where it once lived. It does not mean that a species is extinct.



Eyewire.com

Working together, biologists and trappers have restored river otter populations to much of their former range

Major Factors that Affect Wildlife Populations

- Changes in habitat
- Carrying capacity
- Limiting Factors such as food, weather, & predation

Extinction means a species is no longer found anywhere. Passenger pigeons, for example, are extinct.

Wildlife agencies and supporters have restored many species that were once extirpated from entire states. River otters, fisher, and beaver are furbearers that were extirpated from many states and later restored.

Furbearer Management



USDA Photo

Beaver damage



FWS Photo

FWS employee sets trap for problem beaver

Wildlife populations are usually highest in the spring after young have been born.

supply systems. When furbearer populations cause too many problems, biologists may decide to reduce the numbers below the area's biological carrying capacity. In this case, biologists are managing for additive mortality to bring the population down to its cultural carrying capacity.

Identify regulated trapping as the most efficient and practical means available to accomplish regular furbearer population reductions

Regulated trapping is an important part of wildlife management programs. The regulated use of the furbearer resource is not only acceptable but in some cases has significant benefits. When furbearer populations cause conflicts with people, or with other wildlife species and habitats, biologists may adjust trapping regulations to increase the harvest and reduce the population. Regulated trapping is the most efficient and practical means available to reduce furbearer populations and it does so at no cost to the public.

While furbearer population reduction is not a goal for all furbearer management programs, population reduction in specific areas can be beneficial. Furbearer population control can reduce the number of furbearer problems with people; lower predation on rare, threatened, or endangered species; or reduce damage to habitats and property.

Identify situations where trapping is used to directly manage wildlife

Regulated trapping helps manage wildlife and habitats. Trapping is used to protect many rare and endangered species of plants and animals, wetland habitats, and personal property. Regulated trapping is also used for localized disease control, wildlife research, and wildlife restoration.

In 1997 the U.S. Fish and Wildlife Service (FWS) reported trapping was used on 487 management projects at 281 National Wildlife Refuges.

The case of the piping plover, a beach nesting bird, is a good example. The piping plover is a threatened shorebird protected by the United States and Canada. Foxes, raccoons, mink, and striped skunks prey on piping plovers when they nest. The U.S. Fish and Wildlife Service uses trapping in and around piping plover habitat to reduce local populations of these predators. Some of the other rare species protected by trapping programs include pink lady slippers, pitcher plants, the desert tortoise, sea turtles, Attwater's prairie chickens, brown pelicans, least terns, and black-footed ferrets.

Safety - Animal Welfare - Responsibility - Furbearer Conservation



Beaver, muskrats, coyotes, raccoons, opossums, red foxes, mink, and other animals are often trapped to protect local habitats and personal property. Traps are the only efficient and practical tool that can be used to remove these animals.

Explain the three major issues related to furbearer management

Three major issues affect the conservation and management of furbearers. These include:

- Human population growth, which degrades and destroys habitat
- Public intolerance of furbearers
- Opposition to any use of wildlife by animal rights groups

Human population growth causes the loss of furbearer habitat. The range of some furbearer populations has already been reduced. Habitat destruction has eliminated the possibility of restoring some furbearing species to areas they once inhabited. Unlike habitat destruction, regulated trapping is a sustainable use of furbearers. Trapping does not threaten the continued existence of furbearer populations.

Public intolerance of furbearers is another issue. As wildlife habitat continues to be split up by development, biologists are faced with new challenges. Examples include coyotes killing pets, beavers cutting landscape trees or flooding roadways, raccoons invading homes, and human health threats from diseases such as rabies. These problems are highly publicized and they make some people want to lower or eliminate furbearer populations. As a result, nuisance animal trapping has become a growth industry. This concerns biologists because it shows increasing numbers of people view furbearers as problems that should be destroyed, instead of valued resources that should be conserved and used.

Animal rights activists reflect a different view, which goes against traditional values of using animals for food, clothing, and other purposes. Activists want to eliminate all trapping and stop managing furbearers. If animal rights activists are successful people will have fewer options for solving furbearer problems. Additionally, people could not use furbearers the way they do now.



USDA Photo

Predator trapping has helped the endangered California Least Tern recover from near extinction



FWS Photo

Wildlife biologists face challenges:

Human population

Public intolerance for furbearers in populated areas

Opposition to sound management by animal rights groups

The U.S. Department of Agriculture has a Wildlife Services Program to manage damage, minimize wildlife threats to public health, resolve conflicts with wildlife in urban areas, protect property, protect endangered species, and preserve natural resources. Trapping is an essential tool used by Wildlife Services employees.

Furbearer Management



FWS Photo

Activists oppose fishing, hunting, and trapping



Excise taxes are collected on firearms, ammunition, and archery equipment to support wildlife management programs

Identify two funding sources for furbearer management programs

Hunters and trappers provide most of the money for wildlife management programs. The two major sources of funding include:

- Hunting and trapping license revenues
- Excise taxes on firearms, ammunition, and archery equipment

Hunting and trapping licenses are sold by states and provide direct revenue for furbearer management. Excise taxes on equipment are distributed by the U.S. Fish and Wildlife Service under the Division of Federal Assistance in Wildlife Restoration Act. Wildlife Restoration dollars, sometimes more than \$200 million a year, are distributed to all 50 states, territories, and Puerto Rico for approved programs that involve wildlife research, management, land purchases, and education.

Chapter 4

Trapping Regulations



Content Standard - *Students demonstrate the ability to understand, support, and comply with trapping regulations*

Introduction

Biologists use hunting and trapping regulations to manage and conserve wildlife. When an animal population is low or endangered, regulations can be used to protect the species. When an animal population is high, biologists can allow more harvest, using the principle of additive mortality. If the population of a species is high enough to cause problems biologists may lengthen the season, raise bag limits, or allow additional methods of harvest so the population can be lowered to an acceptable level.

Hunting and trapping regulations are also used to enhance human health and safety; protect habitat, property, and domestic animals; require the use of selective trapping methods; and meet public expectations for animal welfare.

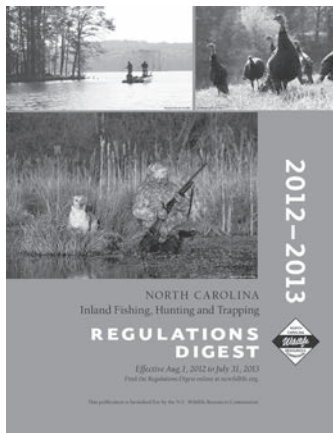
Most states have a process for setting regulations that allows for public participation. Hunters, trappers, landowners, organizations, and government agencies can participate in the regulation setting process.

As a responsible trapper, you must follow all regulations. If you disagree with a regulation you should participate in the regulation setting process.

Each state has law enforcement officers dedicated to enforcement of hunting and trapping regulations. They may be known as wildlife officers, conservation agents, or game wardens. Responsible trappers work with their local wildlife officers and help develop mutual respect for the role each serves in wildlife conservation. When landowners have furbearer control problems wildlife officers often refer them to responsible trappers they know and trust.

Identify two specific places to obtain current trapping regulations

Each state wildlife agency publishes a brochure that explains current hunting and trapping regulations. A copy of this brochure should have been given to



Wildlife officers have an important job. Officers strictly enforce trapping regulations. They may also help teach trapper education courses and work on nuisance animal complaints.



you with your trapper education manual.

Since trapping regulations may change each year you need to obtain a new copy of the regulations when you renew your trapping license. The most common place to find the brochures is at the location where you purchase your license. You may also obtain the regulations by writing, calling, or visiting a wildlife agency office. In addition, most states publish hunting and trapping regulations on their Web site.

In the space below write down two specific places where you can obtain trapping regulations for your state.

In the space below write down the Web site address for your state fish and wildlife agency.

Explain the process for setting or changing trapping regulations in your state

In the space provided outline the process used to set trapping regulations in your state. Obtain this information from your instructor or your wildlife agency.

Flexible trapping regulations allow biologists to use trapping as a tool of wildlife management

It is your responsibility to know the trapping regulations. Ignorance of the law is no excuse if you are charged with a trapping violation.



Silvertip Productions

Trappers work with wildlife agencies to improve regulations

Trapping Regulations



Ohio DOW Photo

When furbearers are too abundant, biologists can reduce restrictions on trapping

When furbearers are too scarce, biologists can shorten seasons or take other steps to allow the population to increase

Some states require trappers to tag traps with the owner's name and address



Ohio Dow Photo

Trapping License & Tags

Explain conditions that could lead to changes in trapping regulations

- Furbearer populations rise or fall
- Trapping technology improves
- The number of trappers rises or falls
- Habitat changes
- Nuisance animal problems increase
- Public attitudes change
- Rare or endangered species need protection from furbearers

Demonstrate the use of your current state regulation brochures to find trapping seasons, legal trap types, legal trap sets, and tagging requirements for common furbearers

Choose two common furbearers and use your state's current regulation brochure to fill in the information in the following table.

Furbearer		
Season		
Legal Traps		
Legal Sets		
Tagging Requirements		

Demonstrate the use of your state's regulation brochure to find requirements regarding permission to trap on private property

Requirements regarding permission to trap vary from state to state. A responsible trapper always obtains permission from the landowner.

In the space that follows write down the trapping permission requirements for your state. Use your state's regulation brochure to find this information.



Demonstrate use of current state trapping regulations to determine legal restrictions for trapping nuisance animals

State wildlife agencies may authorize landowners or specially licensed trappers to remove nuisance animals that damage crops, livestock, or property. Use your state's regulation brochure to find the following information and write it in the space provided:

- Under what conditions can nuisance animals be trapped or removed?
- Who may trap nuisance animals?
- What special licenses or training is required?
- What record keeping and reporting is required?
- What type of fees may be charged?



Ohio DOW Photo

Treat landowners with respect

Always ask for permission before trapping on private land

Try to handle nuisance furbearer problems during trapping season when the pelts are prime

Trapping Regulations



FWS Photo

Federal Agent with confiscated furs

Regulations concerning possession of furs during the closed season vary widely. Make certain you know the laws for your state!

Penalties

Fines & Jail time
Loss of Equipment
License Revocation

Public Shame
Criminal Record
Loss of Respect

Most states have toll-free numbers where you can report violations.

To Report Violations in North Carolina call 1-800-662-7131

State the maximum penalties for trapping out of season, trapping without a license, trapping without permission, and trapping protected animals

Violations of a state’s hunting and trapping regulations are criminal offenses. Conservation officers and judges recognize the difference between an unintentional violation and willful intentions to poach animals out of season or by illegal means. Ignorance of hunting and trapping laws is not an excuse. Hunters and trappers are expected to know the regulations and follow them.

Upon conviction of hunting or trapping violations, a judge may impose fines or jail time. Hunters and trappers convicted of serious violations may have traps, firearms, and even vehicles confiscated by the court. Judges can also revoke licenses and suspend a person’s privilege to hunt or trap in the future.

Using your state’s regulation brochure, write down the maximum penalties for violating state trapping laws in the space provided.

Explain the process for reporting wildlife violations

As a trapper, you may learn about hunting or trapping violations that need to be stopped. Never confront a violator or get directly involved without an officer present. Instead, observe the situation and quickly report it to your local wildlife officer. Provide descriptions of the violators, vehicles, license plate numbers, locations, and times.

Most states have established programs to stop poaching with toll-free telephone numbers to call when you need to report a violation. These programs go by names such as “TIP” which stands for “Turn In a Poacher.” Many states provide rewards for information that leads to the arrest and conviction of violators. Callers can remain anonymous.

Safety - Animal Welfare - Responsibility - Furbearer Conservation



Write the phone numbers of local wildlife offices and your state's TIP program in the space below:

Describe the process for reporting a wildlife violation in the space below:



Silvertip Productions

Poaching is a crime!

Protect wildlife resources and the heritage of trapping by turning in poachers

Chapter 5

Best Management Practices



Trapping BMPs

Sustaining the Future of Trapping



Eyewire.com

Raccoon

All 50 state fish and wildlife agencies support the development of best management practices

32 state fish and wildlife agencies have been actively involved with the BMP program

Trappers, veterinarians, and university researchers helped wildlife agencies evaluate more than 70 types of traps

Content Standard - *Students understand Best Management Practices for Trapping are needed to address animal welfare, trapping efficiency, selectivity, and safety in furbearer management programs*

Introduction



In 1996, the International Association of Fish and Wildlife Agencies began a program to develop Best Management Practices (BMPs) for trapping as a way to improve the welfare of captured animals, and to document improvements in trapping technology. This project is one of the most ambitious in the history of the conservation movement.

BMPs are necessary to sustain regulated trapping as a wildlife management tool, and to maintain the integrity of wildlife conservation programs throughout the United States.

State the name of the organization that coordinates development of best management practices for trapping

The International Association of Fish and Wildlife Agencies (IAFWA) coordinates the development of BMPs for trapping. IAFWA's membership includes all 50 state fish and wildlife management agencies, federal agencies, and conservation organizations.

State furbearer biologists, veterinarians, trappers, and scientists from the University of Georgia and the University of Wyoming cooperated on the development of BMPs. The United States Department of Agriculture provided most of the funding for Trapping BMP research and development.



Explain that BMPs are based on scientific information and professional experience about current traps and trapping technology

BMPs are based on the most extensive research effort of animal traps ever conducted in the United States. Traps tested were selected based on knowledge of commonly used traps, previous research, and input from expert trappers.

Recognize that the Trapping BMP Project is designed to provide wildlife management professionals in the United States with the data necessary to assist in improvements to animal welfare in trapping programs

Trapping BMPs were developed to give wildlife professionals information they need to improve animal welfare. State fish and wildlife agencies will use BMPs to continue the improvement of trapping systems throughout the United States.

Recognize that trapping BMPs are intended to be a practical tool for trappers and wildlife biologists to use for decision-making in the field

Trapping BMPs include suggestions on practices, equipment, and techniques that will provide trappers and wildlife biologists with practical information to use in the field. These suggestions will improve animal welfare, help avoid the unintended capture of other animals, and increase public support for trapping,

Identify BMP criteria for the evaluation of trapping devices including animal welfare, efficiency, selectivity, practicality, and safety

BMP traps were evaluated using criteria to measure the effects on animal welfare as well as trapping efficiency, selectivity, practicality, and safety.

Animal Welfare - Researchers tested live restraining traps for injuries to furbearers using two methods. One system evaluated specific injuries, and the other grouped the injuries into categories from mild to severe. BMP approved traps must have a low rate of injuries to the furbearing animals being studied.

Wildlife veterinarians examined thousands of trapped furbearers for different types of injuries



Eyewire.com

More than 150 teams of trappers and technicians participated in field testing

Each state wildlife agency decides how to incorporate Best Management Practices into trapper education and furbearer management programs

BMPs are valuable tools for biologists and trappers

BMP recommended traps resulted in no, little, or moderate injury to at least 70% of the animals trapped

Traps that failed to capture and hold at least 60% of the species targeted did not qualify for recommendation

Best Management Practices

Traps and sets must be selective

Experienced trappers evaluated cost, ease of use, trap weight, reliability, and other factors



Eyewire.com

Canada Lynx

As new BMP information is published it is distributed by wildlife agencies, IAFWA, and trapping associations in print and online

Recommended traps resulted in moderate, low, or no injury to at least 70% of the animals trapped.

Efficiency - Traps meeting BMP criteria must be able to capture and hold at least 60% of the furbearers that spring the trap.

Selectivity - Traps must be set and used in a fashion that limits the risk of capturing non-furbearing species while increasing the chances of capturing the desired furbearer.

Practicality - Each recommended live restraining trap was evaluated by experienced trappers and wildlife biologists for practicality. Criteria used to measure practicality include cost, ease of use, ease of transport, storage, weight and size, reliability, versatility, and the expected life-span of the trap.

Safety - Each recommended live restraining trap was evaluated for safety to the user and other people who might come into contact with the trap.

Identify where to find detailed BMP information for each furbearer

State fish and wildlife agencies have access to Trapping BMP publications as they are developed. Trappers can find all current information on Trapping BMPs at the following Web site:

- <http://www.furbearermgmt.org>

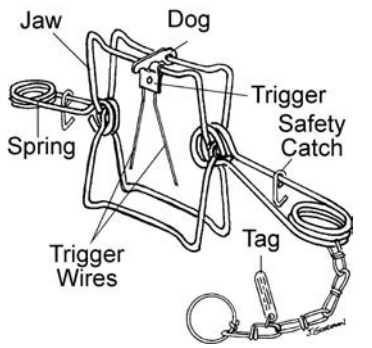
The Furbearer Management Web site is maintained by the International Association of Fish and Wildlife Agencies on behalf of state fish and wildlife agencies, trappers, and trapping organizations.

Chapter 6

Traps

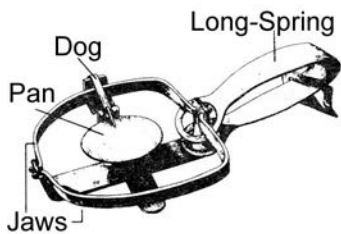


Legal traps vary from state to state. Trapping regulations may change each year within a state.

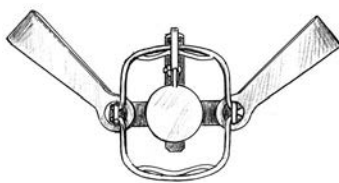


Joe Goodman

Kill-Type Body-gripping Trap



Live-restraining long-spring with plain jaws



Live-Restraining Double Long-spring Foothold Trap

Content Standard - *Students demonstrate the ability to identify types of traps, prepare traps for use, and safely operate traps*

Introduction

Some of the traps described in this chapter may not be legal to use in your state. Regulations vary from state to state, and from year to year within states. Know the regulations for your state, and follow them.

Identify traps as kill-type or live-restraining devices

Some traps are designed to kill furbearers. The most common kill trap is a body-gripping trap, also known as a Conibear™ type trap. State regulations place limits on trap sizes, and locations where sets can be made.

Live-restraining traps are designed to capture an animal alive and unharmed. The most common live-restraining traps include foothold traps, cable devices, and cage traps. These traps allow you to release non-target animals.

You will also learn how to make submersion sets using foothold traps. The proper use of submersion trapping techniques results in the death of a furbearer.

Identify live-restraining traps, including long-spring and coil-spring foothold traps, guarded traps, enclosed foothold traps, and cable devices

The most common types of foothold traps include long-spring and coil-spring traps. Foothold traps come in various sizes and strengths, each of which is appropriate for one or more specific species of furbearers. At one time trappers also used underspring traps, but this style has not been manufactured for many years.

Safety - Animal Welfare - Responsibility - Furbearer Conservation



Advantages of foothold traps include versatility, small size, and the ability to release animals. Foothold traps and cable devices are the most reliable traps for coyotes, red fox, and gray fox.

Long-spring traps are the oldest type of foothold traps. Single long-spring traps are best suited for small animals like mink and muskrat. Long-spring traps are heavier than coil-springs. Double long-springs are a better choice for water sets made for large animals such as beaver.

Guarded foothold traps are used where kill-type traps are not suitable for capturing muskrats in shallow water. The spring-loaded guard restricts an animal's movement making it less likely they will twist free or injure themselves trying to get out. It is better to use small kill-type traps, or footholds in a submersion set, for trapping muskrats.

Coil-springs are the fastest kind of foothold trap. They work well in land sets for fox and coyote because of the coil-spring's speed, strength, and compact size.

Enclosed foothold traps are designed to catch raccoons and opossums. Brand names include EGG™, Duffer's™, and Lil' Griz™ traps. These designs almost eliminate non-target catches because raccoons or opossums must reach through a small opening to trigger the trap.

Trappers set EGG™ and Duffer's™ trap springs at home, not in the field. Initial set construction is faster with these traps than standard footholds, but they take longer to reset because they must be disassembled to remove the animal and reset the springs.

Coil-spring activated cable devices are another kind of foothold device. These traps use 1/8" cable set in a loop triggered by two quick-release springs. A stop lock is used to keep the cable from closing below a certain diameter. The stop lock allows smaller non-target animals to escape. Cables used on these traps may need to be replaced frequently due to kinking or other damage.

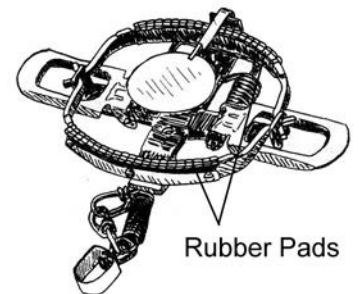
Identify jaw frame characteristics and modifications including plain jaws, padded jaws, offset jaws, double jaws, and laminated or wide jaws

Several BMP traps are identified by jaw frame characteristics and modifications. Padded foothold traps have rubber pads on the jaws. Some foothold trap designs use offset jaws. The offset creates a space between the gripping surfaces when the jaws are closed. The offset ranges from 1/8 to 1/4 inch.



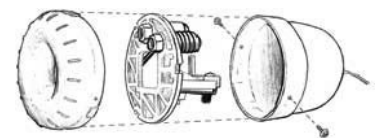
Silvertip Productions

Guarded Foothold Trap

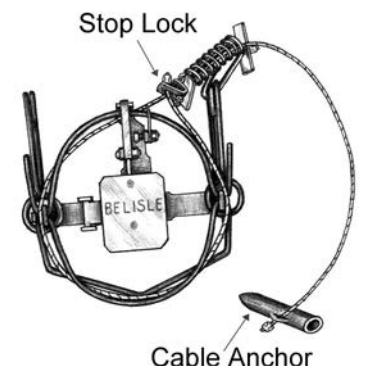


Joe Goodman

Coil-spring Padded Foothold Trap



EGG™ Trap



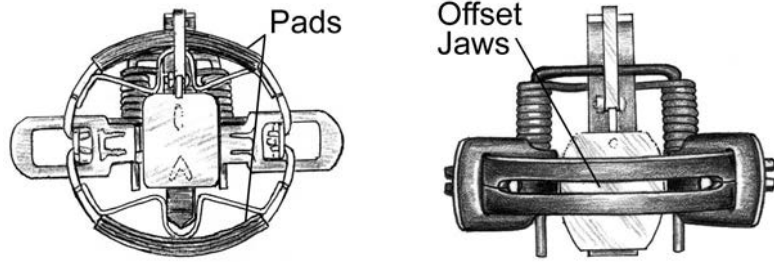
Spring-activated Cable Device

Traps



Texas Parks and Wildlife

Gray fox in foothold trap



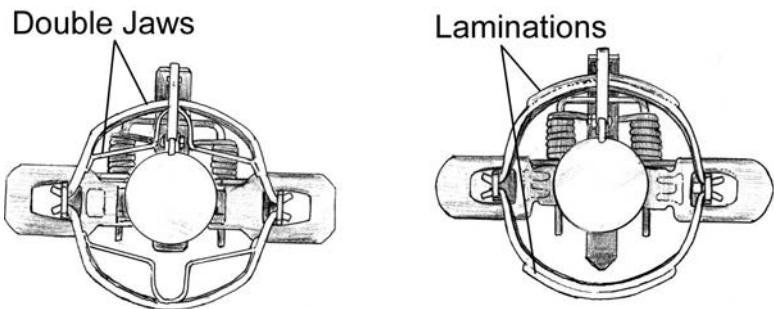
Double jaw traps use two metal frames instead of one. One set of jaws is smaller, and these are inside of the regular jaws.

Laminated (wide) jaws are another option that can increase efficiency and reduce injuries. Lamination is normally added by welding an additional strip of metal to the top or the bottom of the jaw that sits perfectly flush with the original jaw. Some trappers also use double lamination, welding one strip above, and one below the jaw. Lamination expands the jaw thickness and increases the amount of surface area holding the animal's foot.



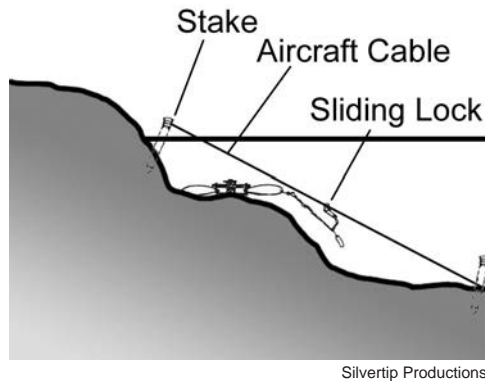
Joe Goodman

Laminated trap jaws



Know that foothold traps can be used in submersion sets for muskrats, mink, river otters, nutria, and beaver

Foothold traps are generally classified as “live-restraining” traps. However, foothold traps can be used in submersion sets to ensure death. To make a submersion set, use slide-wire “drowners”, which consist of a length of aircraft cable (3/32” or 1/8”), or strong wire (11 or 12 gauge), with a one-way sliding lock. One end of the cable is staked near shore where the trap is set. The other end of the cable is staked or anchored in deep water (minimum 24” deep for muskrats and 42” deep for beaver). The one way sliding lock allows the animal to swim toward deeper water, but not back to shore. The weight of the trap forces it to submerge. Another option for muskrat trapping is to stake the trap in deep water. The weight of a long-spring trap will submerge a muskrat.



Although submersion sets are commonly called drowning sets, the animals do not actually drown. Technically muskrats, mink, river otters, nutria, and beaver are unable to breathe under water, and they asphyxiate. The term submersion set is more accurate.

Advantages of using submersion sets include:

- Ensures death of trapped animals
- Fewer escapes and less pelt damage
- Less chance of trap or fur theft
- Less disturbance at the set

Disadvantages of using submersion sets include:

- Initial cost is higher
- Takes more time to make the set

Identify kill-type devices including body-gripping traps

The most common kill-type devices are body-gripping traps, also known as Conibear™ traps. Conibear is the name of the inventor. When an animal triggers a body-gripping trap, two rotating jaws close on the animal's neck or chest. Body-gripping traps are generally used in water sets for mink, muskrat, and beaver. States normally restrict the use of body-gripping traps on land to the smaller sizes. These traps must be used with caution, especially on land, to prevent the capture and death of non-target species.

Larger body-gripping traps can pose a risk to a careless trapper. It is best to use the buddy system when trapping, especially if you are using large body-



Silvertip Productions

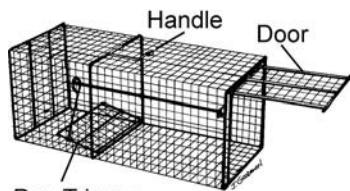
Muskrat Trappers

Traps

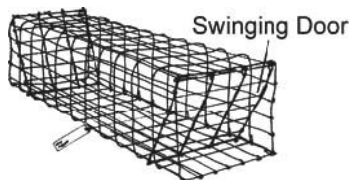


Joe Goodman

Body-gripping traps should be set to close from top to bottom to work properly



Live-restraining cage trap



Kill-type submarine or colony trap



Massachusetts Div Fisheries and Wildlife

Biologist with Hancock Trap - a large live-trap for beaver

gripping traps. If you accidentally spring one on your hand or arm it can be difficult to release the trap. You can use a rope with a loop in one end to free yourself as described in other parts of this manual.

Identify live-restraining cage traps and kill-type colony traps for use in submersion sets

Cage traps may be difficult to use because of their size. Raccoons, skunks, opossums, fisher, and weasels can be caught in cage traps. Fox and coyotes may avoid cage traps. If you need to trap near buildings or in areas used by pets cage traps are a good choice.

Submarine or colony traps are a type of cage trap designed to be used in submersion sets for muskrats and mink. It is called a colony trap because you can catch an entire family, or colony, of muskrats at one time. Check regulations before using a colony trap in your state.

Identify non-powered cable devices, powered cable devices, relaxing locks, and non-relaxing locks

Non-powered cable devices consist of a cable, a lock, and a swivel. These devices catch animals by the neck or body. A cable device should be equipped with a swivel, and set in an area where a restrained furbearer will not entangle it on brush, fences or saplings. Larger furbearers such as beaver, fox, and coyote can be caught with cable devices. Use cable devices cautiously since they could hold livestock, deer, or other animals. Trappers can use a “stop” on the cable that restricts the loop from closing below a certain diameter, allowing non-target animals to get out. The use of a “break-away” lock system allows larger animals, such as deer, to break the device loose and go free.

Relaxing locks move in both directions on a cable. Non-relaxing locks only slide in one direction. If an animal pulls against the cable it gets tighter and will not release.

Powered cable devices are used to catch animals by the foot. The cable loop is mounted on a device that looks similar to a foothold trap. When the animal steps on the pan, it trips v-shaped coil-springs similar to those found on body-gripping traps. The cable loop has a stop to prevent it from closing below a certain size, so that small animals will escape. Although relatively new, this trap has been tested and approved for use in trapping Eastern coyotes as part of the BMP trap testing project.



Another type of powered cable device uses heavy duty springs to kill an animal by making the cable close tight around the neck or body.

Identify trap anchoring systems including single stakes, cross stakes, earth anchors, drags, grapples, and springs

Traps must be attached to something to hold an animal. Normally a chain is attached to a foothold trap. Trappers can use several methods to secure the chain to a stake or another object. Stakes are normally made of metal and are used to secure the chain to the ground. A stake needs to be long enough to hold the largest animal that might be caught. Under most conditions stakes should be 18-24 inches in length. Even longer stakes are needed in sandy soils. Fox and coyotes require a more secure method to keep the captured animal from pulling the stake out. Trappers use a cross-staking method for these stronger animals. If the stakes do not hold well, you must find a new place to make your set. You must not let an animal escape with a trap on its foot because it will cause injury.

Some trappers use earth anchors, attached to a cable which is driven into the ground with a tool. Earth anchors are very strong, and need to be dug out of the ground when you remove the set.

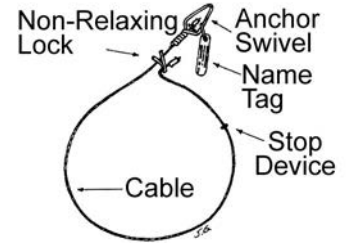
Traps can be attached to drags in some sets. Drags allow an animal to move a short distance. Heavy tree limbs are a common type of drag. Grapples are metal devices secured to traps with chains. Grapples work like drags, but they are not as heavy. The shape of the metal grapple causes it to dig into the ground or vegetation, restricting the furbearer's movement.

Shock springs can be used in combination with chains, stakes, drags, and grapples. One or two shock springs can be used to help hold animals, such as coyotes, that have a habit of lunging when trapped.

Explain how swivels are used and why they are important

A variety of good swivels are needed for quality sets that catch and hold certain furbearers. Swivels reduce the chance of injury by allowing a trap to move freely in the same direction as the animal's foot.

Lap-link swivels, stake swivels, and universal swivels can be used to fasten a chain to a stake. When two stakes are needed trappers use a special cross-



Joe Goodman

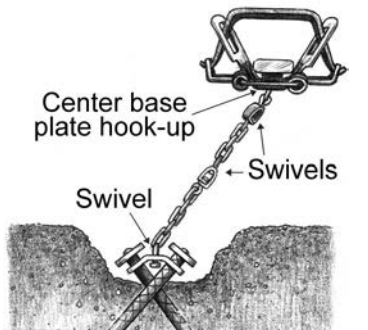
Cable Device



Stakes



Earth Anchor

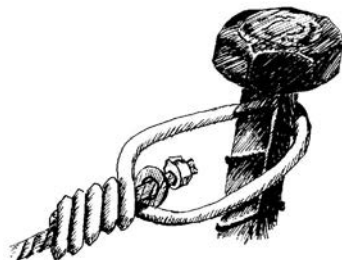


Joe Goodman

Cross-staking



Double Long-spring



From "Missouri Cable Restraint Training Manual." Copyright 2004 by the Conservation Commission of the State of Missouri. Used with permission.

End Swivel



From "Missouri Cable Restraint Training Manual." Copyright 2004 by the Conservation Commission of the State of Missouri. Used with permission.

End Swivel with Box Swivel

staking swivel.

Universal swivels can be used in the middle of chains. Four-way swivel is another name for a universal swivel. A universal swivel is also used to attach the chain to a trap at the center of the base-plate.

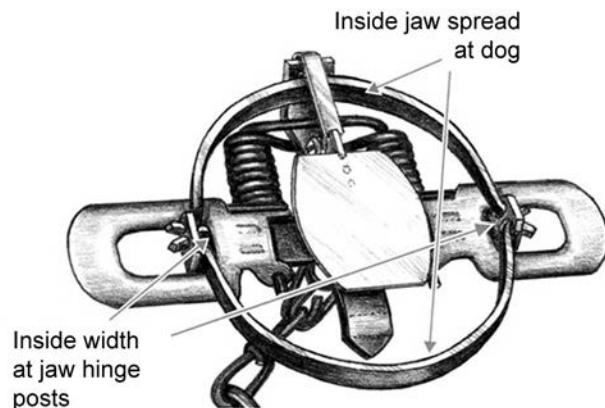
S-hooks are used on some swivels. A special s-hook tool can be used to close the hook without damaging it. Coyote trappers weld the connection to keep it from pulling open.

Swivels of various types, including universal swivels, are also used in combination with sliding locks in submersion sets.

Always use the highest quality swivels in your trap systems to prevent an animal from escaping or being injured. The proper use of swivels is an important part of responsible trapping.

Demonstrate methods of measuring jaw spread at dog and jaw spread at hinge posts

There is no standardized way of determining a trap's measurements using manufacturer designations such as "No. 2" coil-spring. To find traps that meet jaw spread measurements for BMPs or state regulations you may need to check jaw spread in two places: at the jaw, and at the hinge posts.

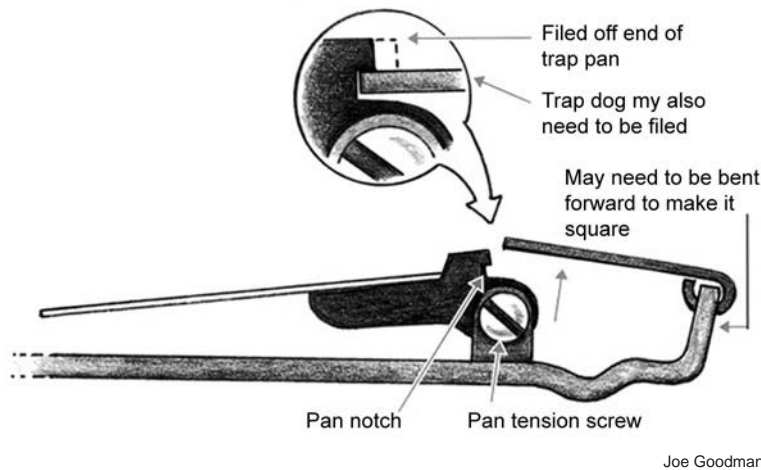


You can take these two measurements by setting the trap. Carefully measure the inside spread of the jaw frame at its widest point along the line from the dog to the opposite side. Then measure the width between the two jaws where they connect to the hinge posts. You may find slight differences in jaw spread measurements on the same make and model of traps.



Demonstrate trap-tuning procedures including the abilities to file a trap jaw to remove sharp edges, level trap pans, adjust pan tension, and adjust the pan throw

New traps require some minor adjustments to operate most efficiently. When you make these adjustments it is called “trap tuning.” You also need to inspect and tune your traps before the start of each season.



When the trap is set the trap pan should be level with the jaws. If the pan rests too high or too low you will need to bend the frame in or out below the “dog”. Bend it out to raise the pan. Bend it in to lower the pan.

Pan tension is another adjustment. It is measured by the amount of weight it takes on the trap pan to fire the trap. Most new traps have pan tension adjustment screws. When trapping larger animals, increase the tension so that smaller species will not trigger the trap. For example, two pounds of pan tension is a good setting for fox. You can purchase a commercial testing device to measure pan tension. You can also use a tennis ball can, liquid soap container, or PVC pipe filled with the weight of sand that matches your desired tension. Pan throw is another adjustment. Pan throw is the distance the pan must be depressed to fire the trap. Use a shorter pan throw when tuning a trap for high pan tension. To adjust the pan throw, you file some metal off the end of the notch where the dog fits. This notch determines how far the pan must drop before the trap will fire.

Use a file to make certain the end of the dog and the notch in the trap pan are squared off. If the dog or the notch is rounded, your trap may release too easily.

Body-gripping traps may require trigger adjustment. If there is too much play

- Weak springs should be replaced
- Swivels and hooks must be strong and operate freely without binding
- Weld the ends of trap hooks if you are trapping coyotes or other large animals
- Use a metal file to smooth down any sharp or rough edges on the jaws
- Check chains for worn links
- Make certain your traps are tagged to comply with state regulations



Silvertip Productions

Use weight to test pan tension

Increase pan tension by turning the pan tension screw to the right, or clockwise. Turn the pan tension screw to the left to decrease pan tension.

in the trigger your trap may misfire, or strike the animal in a poor location. If there is a gap in the top of the trigger assembly you can crimp it with a pair of pliers or a vise until the ends are flush.

Experienced trappers adjust the shape of triggers on body-gripping traps to make them selective for certain species of furbearers. See “Selective Trapping Techniques” Chapter.

Explain the process and the purpose for cleaning, rusting, dyeing, and waxing new traps; and why body-gripping traps should not be waxed



From "Missouri Cable Restraint Training Manual."
Copyright 2004 by the Conservation Commission of
the State of Missouri. Used with permission.

Coyote Tracks

New traps are shipped with a light coating of oil that needs to be removed. Put a nail between the jaws of each trap. Put the traps in a large wash tub and fill it with water and powdered automatic dishwasher detergent. Boil the traps in the soapy water for 30 minutes then remove and rinse them clean. Hang the traps outside until a light coating of rust forms. This may take one to two weeks. The rust will help the dye bond to the metal without hurting your traps.

When your traps are lightly rusted they are ready to dye. Logwood powder or crystals can be used to dye traps. Put your traps in a large washtub over a fire or a propane cooker. If you use a commercial logwood dye follow the directions on the package for the proper amount of water and logwood ingredients. Bring the water to a boil before adding the logwood.

Let the traps soak in this solution for 30 to 60 minutes. The longer you leave the traps in the solution, the darker they will get. If the traps are heavily rusted you can take the washtub off the fire and leave the traps in the solution for a day or two.

High temperatures can weaken your trap springs so it is best to lower the water temperature to a simmer after you add the traps. A propane cooker allows you to adjust the heat easier than an open fire.

Walnut hulls and maple bark contain tannic acid, just as logwood does. As an option to buying logwood, you can boil walnut hulls or maple bark for an hour before adding your traps.

Some trappers prefer to use petroleum-based dips to color and protect their traps. Note: If you are using padded jaw traps, do not dip the pads. No fire is needed with dips. These products are fast and simple. Add unleaded gas or lantern fuel to the dip according to the directions. You simply dip your pre-rusted traps in this solution, and then hang them outside to dry. You will get a harder and more even coating if you use petroleum-based dips when the air tempera-

Safety - Animal Welfare - Responsibility - Furbearer Conservation



ture is above 70 degrees F. Always read and follow manufacturer's directions.

Waxing is another way to protect traps and make them operate faster. To wax traps, submerge them in boiling water. Place trap wax in the water and let it melt. The wax will float. Using a hooked stick, slowly and carefully lift the traps out of the water one at a time. The traps should come out with a thin, even coat of wax. Shake the traps to remove excess wax. If the wax is too thick or too heavy, put the traps back in the water and allow them to heat a bit longer before removing them.

Some trappers prefer to dip their traps in pure wax with no water. Exercise caution because trap wax is flammable. Wax can catch fire, or cause severe burns if it splashes on you.

A less traditional but safer and easier way to wax traps is to dip them in acrylic floor wax at room temperature. This covers your traps with a thin, even coat that tends to last longer than other waxes.

No matter how you wax traps, make certain you keep the wax and the container free of odors. Furbearers have a keen sense of smell. If your traps have odors on them furbearers may shy away from your sets. If the odor is an attractive one, the furbearer may dig it up and ruin your set.

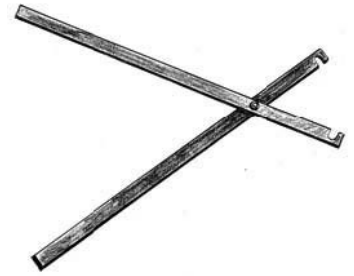
Body-gripping traps require no waxing. It makes them slippery and dangerous. Petroleum based dips or dyeing is acceptable for body-gripping traps.

If you have waxed or dipped a foothold trap, you must clean the end of the dog and the pan notch. If you do not remove the dip or wax, the trap will not stay set. Use a file to clean wax or dip off of these parts.

Demonstrate how to safely set and release at least one type of foothold trap and to safely set one common kill-type device

It is important that you develop skills setting traps so that you can understand the way they work and use them safely. Working with an instructor, or an experienced trapper, select at least one type of foothold trap and practice setting it. Have your instructor or mentor show you how to release the trap safely. Practice with your instructor's help until you can do it correctly.

Single long-spring traps are easier to set than coil-spring traps. To set a coil-spring, place the palm of each hand on one of the springs. Press down evenly on both levers at the same time until the jaws open. Once the jaws are open

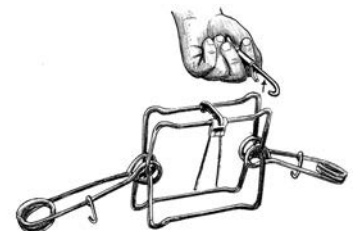


Joe Goodman

Setting tongs

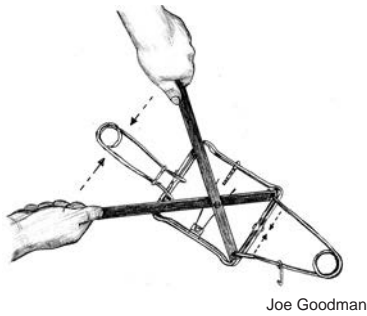


Safety gripper



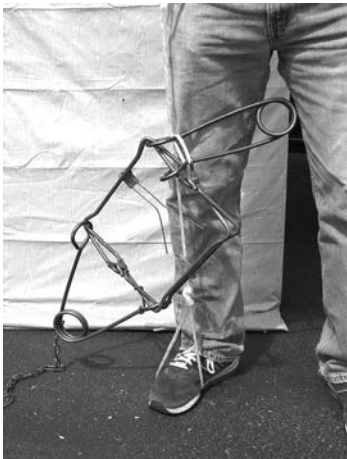
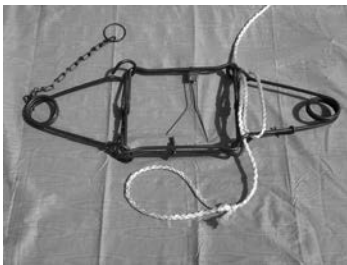
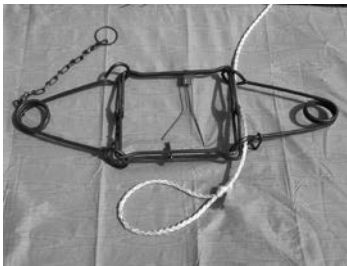
Using safety gripper

Traps



Using setting tongs

Using rope to set body-gripping trap



you can hold them in place with the palm and thumb of one hand. Using the thumb on your free hand, set the dog in the notch of the pan and release a little pressure on the jaws to make certain it is firmly in place. Hold the dog down with one thumb, then raise the free jaw and put your fingers below the jaw and the pan, holding the trap by the base plate. Holding the pan up, put the fingers of both hands under the jaws and the pan, and set the trap in place. With practice, you will get comfortable setting traps. On the trapline, you will need to wear gloves for warmth, and to protect the trap from human odor. It is a good idea to practice while wearing the same type of gloves you will use when making sets.

Practice setting and releasing a kill-type trap. Smaller body-gripping traps have springs that can be compressed by hand. On double-spring models you can keep the springs compressed with safety hooks that can be released once you have your trap in place.

Use setting tongs to set size 220 and larger body-gripping traps. This tool uses leverage to compress the springs and fasten the safety hook. You should use a Conibear™ safety gripper to keep larger traps from firing shut while you are finishing your set. Setting tongs should always be within reach when using large body-gripping traps.

Whenever using a No. 220 or larger body-gripping trap carry a length of rope with a strong loop in it. Keep this rope where you can reach it easily with one hand if you get caught. Put one foot in the loop. Run the rope through the eyes of the spring, then around the eyes and up through the eyes again. Pull on the free end of the rope with your free hand or your teeth until you can set the safety hook for that spring. Then repeat this procedure on the other spring until you relieve enough pressure to remove your hand.

Use extreme caution when setting body-gripping traps under water. If your trap is fastened below the water's surface, or below ice, you could have a difficult time freeing yourself. This is another reason to make certain you trap with a friend or relative.

Chapter 7

Trapping Equipment



Content Standard - *Students identify essential and non-essential clothing and equipment used to set traps and run a trapline*

Describe clothing needed for various trapping methods and weather conditions



Ohio DOW Photo

Trapper dressed in layers

Water trappers will need hip boots or waders

Trappers need clothing for a variety of weather conditions. Weather conditions change over the length of a trapping season, or even during a single day spent checking your trapline.

When trapping on land you need a pair of sturdy rubber boots with soles that won't slip easily on rough terrain, snow, or ice. Keep them free of unusual scents.

Dress in layers. You can remove some clothing if temperatures rise during the day. When trapping in cold weather wool clothing is a good choice. Wool retains heat even if it gets wet. Wool allows perspiration to evaporate, so you don't get damp and cold. Thermal underwear may be needed for the coldest days.

Carry a lightweight parka or rain suit with you when you trap. Rain gear will keep you dry, and block the wind.

Keep your clothes clean and free of unusual scents. Predatory animals like fox and coyotes are especially wary of certain scents. Some kinds of clothing are noisy when you walk. If you move quietly, you will see more wildlife.

Visibility to other people is important during certain hunting seasons. Make yourself easy to see and identify. Trappers may be concerned about being too visible because of concern about trap thieves. From a distance, most people will assume you are hunting if they see hunter orange clothing. Your personal safety is more important than the potential loss of a few traps.

Water trappers need hip boots or waders. Shallow water trappers can use hip boots. Chest waders are needed for deep water, and they can help keep you warm.

Safety - Animal Welfare - Responsibility - Furbearer Conservation



Water trappers often wear Coast Guard approved float coats. These will help keep you afloat if you fall into deep water. Inflatable PFDs are another water safety item you can wear. These are worn like a vest. If you need more flotation you can pull the string on an inflatable, which releases gas into the vest and expands it. A mouth tube should be available to use in case the gas canister doesn't work.

Trappers use a variety of gloves. Water trappers use long rubber gloves to protect their hands and arms from cold water. Canine trappers may use two pairs of gloves, one of which they wear only when handling traps so they keep the traps scent free.

All trappers should have warm hats. Body heat can escape through your head if you do not wear a hat. A hat also protects your head and face from sun and wind.

When you trap, carry a flash light, ice picks, waterproof matches, firestarters, a map, and a compass with you at all times. Keep them in the same place so you will know where to reach for them in an emergency.

Use a flashlight when walking in the dark, even at dawn and dusk. A flash light will help you follow the trail and make you clearly visible to any hunters in the area. You can also use a flashlight to signal searchers if you get lost, become ill, or suffer an injury.

Identify tools, materials, and supplies needed to make sets and run a trapline

Beginning trappers should start out with basic gear needed to trap one or two species of furbearers. If you need to buy all new equipment, you will spend a lot of money. Learn to be successful with basic gear so you can make some spending money from fur sales before you invest too much. As you gain experience you will also learn where to get good prices on equipment, and develop a better sense of the gear needed for other types of trapping.

You can purchase used equipment to save money. Be careful about buying used waders or hip boots. Old boots and waders may leak. Check used traps to make certain they are legal and in good condition before you buy them. Trap springs may weaken over time.

Trap Tags - Check your state trapping regulations for requirements to tag your traps. Many states require the trapper to have his or her name and address attached to each trap.



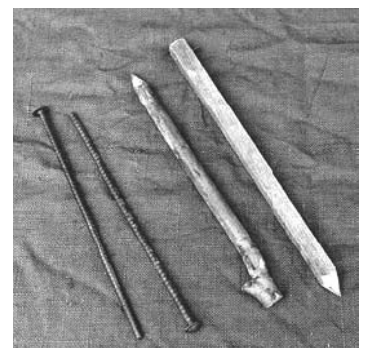
Ohio DOW Photo

Gauntlet gloves

Trappers use a variety of gloves to keep dry and warm. Some canine trappers use separate gloves for handling their traps. This keeps other scents from getting on the trap.

PFD stands for Personal Flotation Device, an inexpensive item that can save your life!

When walking on ice keep ice picks where you can reach them fast. If you fall through in deep water you will need the picks to pull yourself out to safety.



Trap stakes

Trapping Equipment



Ohio DOW Photos

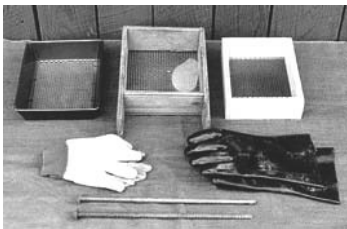
Cable cutter and pliers



Hammer and hatchets



Bucket, bag, and pack basket



Dirt sifters, gloves, stakes for land trapping

Trap Stakes & Grapples - Steel stakes are needed to anchor traps. Know the length and size you need for specific furbearers and soil conditions. You may need to use grapples in certain sets.

Pliers and Cable Cutters - Pliers are needed for trap adjustments, plus cutting and bending wire. If aircraft cable is used for snares or anchoring systems you will also need cable cutters.

Hatchet - A hatchet is used for cutting limbs, driving stakes, chopping ice, and making certain kinds of sets.

Wire or Aircraft Cable - Wire or aircraft cable (3/32 or 1/8 inch) can be used to make submersion sets and fasten traps. Wire can also be used to support cable devices.

Trapping Staff - A staff has many uses. Use a staff to check water depths when wading, detect underwater dens, and retrieve traps from the water. A trapping staff of the proper weight and strength can also be used to dispatch animals caught in live-restraining traps.

Trowel - Trowels are used to make dirt holes or pocket sets in water.

Pack basket, Bucket, or Heavy Bag - Any of these items can be used to carry your other equipment and traps.

Knives - Folding lock back knives are recommended for trappers. You will find many uses for a knife on the trapline.

Dirt Sifter - A dirt sifter is a frame about eight inches square and three inches deep with a quarter inch mesh screen on the bottom. The sifter is used to cover traps with fine soil. Sifters remove rocks or chunks of dirt that could interfere with the trap closing properly.

Pan Covers - A pan cover is recommended to keep dirt and debris from getting under the trap pan on land sets. Wax paper, screen, plastic, and clean patches of cloth are used for pan covers.

Trapper's Cap - A trapper's cap can be used instead of pan covers. This device temporarily fits over the trap pan while dirt is packed inside the jaws. When it is removed it leaves the area beneath the pan free of dirt.

Underalls - Some trappers use pieces of foam rubber or fiberglass insulation cut to the shape of the trap pan and to the thickness of the space under the pan. This is another way to keep dirt and debris from getting under the pan.



Catchpole (Release Noose) - A release noose is used to hold an animal so it can be safely released or dispatched. A catchpole is an essential tool for a land trapper.

Gloves - Trappers use a variety of gloves. Latex gloves are used when skinning animals. Water trappers use gauntlet gloves that cover the arm to the shoulder to keep dry in cold weather. Land trappers use rubber or cotton trap setting gloves to keep human scent off their traps.

Kneeling Pad - Land trappers use cloth, canvas, or rubber pads to kneel on when making land sets. Kneeling pads help keep human odor off the set. The kneeling pad is also a good place to put dirt when digging the bed for a trap.



From "Missouri Cable Restraint Training Manual."
Copyright 2004 by the Conservation Commission
of the State of Missouri. Used with permission.

Catchpole

Many trappers work hard to avoid contaminating their trapping areas with unusual scents or human odor

Chapter 8

Using Bait, Lure, and Urine



Content Standard - *Students explain responsible use of lure, bait, and urine to attract furbearers to sets*

Introduction

Effective use of bait, lure, and urine will increase your catch and help you avoid non-target animals. The more you learn about an animal and its habits, the better you will be at using lure, bait, and urine.

Explain when and how to use bait, glandular lures, food lures, curiosity lures, and urine to attract specific furbearers

Bait, lure, and urine can be used alone or in combinations to help you trap furbearers. Scents should match the interests of the animal you are trying to catch.

Baits are used to attract animals to your sets and make them stay longer. Your choice of bait and its placement is based on the furbearer's food source and eating habits. Baits can be chunks of meat and fish, or plant food such as corn, carrots, and apples. Meat and fish bait may be fresh, tainted, or liquid in form.

Bait must be used carefully to prevent catching non-target wildlife or domestic animals. Pay close attention to trapping regulations concerning bait. Uncovered flesh baits are attractive to hawks and owls, which hunt by sight. Lightly covered flesh baits work for furbearers because they have a keen sense of smell. Baits such as corn may attract a variety of non-target animals.

Lures are used to attract animals to your sets from a distance. Lures are classified as gland, food, or curiosity attractants. Gland lures appeal to an animal's sexual attraction or territorial instincts. Food lures or scents appeal to their desire to eat. Curiosity lures appeal to a furbearer's instinct to investigate something unfamiliar.

If you find a dead animal, do not set traps there, you may catch non-target animals



Ohio DOW Photo

Baits - Canned fish, apple, and carrot

Visual attractants, where legal, are sometimes used. Bobcats, for example, may be attracted to strips of cloth or pieces of metal fluttering in the breeze.

Safety - Animal Welfare - Responsibility - Furbearer Conservation



Food lures are generally most effective in the early part of the trapping season. Gland lures become more important later in the season when the animals are looking for mates. Curiosity lures may work at any time in the season, especially when the animal is not hungry or looking for a mate.

Urine is often used for trapping fox and coyotes. Like dogs, fox and coyotes mark their territory by urinating on various objects. Urine triggers a territorial response that may encourage a coyote or fox to investigate your set.

Some trappers enjoy making their own lures and attractants. It is part of the challenge of becoming a successful trapper. Commercial lures work, but if a certain kind is used frequently animals may become wise to the scent and avoid it.

The use of bait, lure, and urine varies by time of year, location, and the type of furbearer you want to catch. The presence of non-target species or domestic animals will also affect your choice. The responsible use of bait, lure, and urine can make you more successful catching furbearers while avoiding problems with non-target animals. Remember, each non-target animal that comes to your set reduces your chances of catching the animal you want.

Refer to the Appendix A for the species you are trapping to help determine the best bait and lure to use.



Ohio DOW Photo

Urine and lures

Chapter 9

Selective Trapping Techniques



Content Standard - *Students demonstrate an understanding of trapping principles and techniques that increase selectivity of sets*

Introduction

Trapping is a challenging activity. Each time you set a trap, make the set to catch a specific furbearer. You should also take steps to prevent catching pets or other non-target animals. This is known as selective trapping.

Information in this chapter will give you an introduction to selective trapping techniques in preparation for further understanding the chapters on making sets.

Use knowledge of furbearers and their habits to select the best locations and make selective sets

Trap location is the first consideration for selective trapping. Each species of furbearer lives in a certain kind of habitat, eats certain kinds of food, and follows certain habits. Use this knowledge to find the best places to set your traps.

Describe the use of sticks, rocks, or other material to guide target animals to a trap or divert non-target animals away from traps

Sticks and rocks can help you make selective sets. Examples include:

- If you make a muskrat set at the edge of a stream you can avoid ducks and other water birds by sticking branches out of the stream bank above the trap. Muskrats can pass below the branches;
- You can make a rock cubby for raccoons that will keep most dogs from approaching the trap;



FWS Photo

FWS employees use selective techniques for research



Ohio DOW Photo

Rock cubby



- You can place a “jump pole” immediately above a cable device to force deer to jump over it;
- A few small stones can be used as foot guides at land sets to help make the animal put its foot on the trap.

Describe the use of baits and lures that attract a target species and avoid non-target animals

The use of bait, lure, and urine is a key factor in selective trapping. Each furbearing animal will respond to certain food smells. Glandular lures can appeal to a specific animal’s mating urges. Never use pet food for bait. Avoid other baits that might attract dogs or cats. For example, fish might attract cats if you are trapping near homes that have pets.

Explain that properly tuned BMP traps have been tested for selectivity and efficiency

Selecting the proper trap is made easier by studying the BMPs for each species. The size of the jaw spread and strength of the spring can help catch and hold a specific furbearer. Pan tension is an important consideration as well. Try one pound of pan tension for gray fox, two pounds for red fox or bobcats, and four pounds for coyotes.

Use BMP recommended traps and tune them for the specific species of furbearer you want to catch. BMP traps have been tested extensively for selectivity and efficiency.

Describe the importance of avoiding trails and other areas used by livestock, domestic animals, non-target wildlife, and humans

Although furbearers may use trails that are shared by people, pets, and livestock, these are not good places to set traps. Look for more remote places to make your sets. Avoid trapping a property when you know that hunters and dogs will be out for pheasant, quail, grouse, raccoon, or other species commonly hunted with dogs.



Ohio DOW Photo

“Jump Pole” over cable device. This jump pole will fall over to prevent entanglement. Don’t place a jump pole too high or a deer will go under it.

Note: Cable device above is painted white to make it visible in photo

See the “Traps” chapter for information on tuning traps and setting pan tension



Ohio DOW Photo

Avoid trails used by people and domestic animals

Selective Trapping Techniques



Ohio DOW Photo

Make friends with other people who use the property where you trap

Avoid trapping in any area where people regularly exercise pets



Ohio DOW Photo

Trap placement is an important selectivity consideration

Explain the importance of discussions with landowners and people who regularly use private lands where you intend to trap

Responsible trappers make an effort to learn all they can about property they trap and who might be using the property for other activities. Find out who else has permission to be on the property and when they will be there. This will help you avoid problems and you may make some new friends in the process.

Explain the importance of planning when, where, and how to trap on public land to avoid catching hunting dogs

Public areas provide millions of acres of land and water where trapping is permitted. During times of heavy public use for hunting it is a good idea to focus on water trapping to avoid catching dogs. Since most furbearers are nocturnal you can make sets in the evening and pull them or trip them the next morning. Local managers, rangers, or wildlife officers can tell you about the most heavily used hunting areas so that you can avoid them when hunters are running dogs.

Explain how variations in trap placement at a dirt-hole set can increase selectivity

Trap placement in relation to lure, bait, or other attractors is another factor in selective trapping. At a dirt-hole set, for example, try placing the trap 7" from the hole for fox, and 12" for larger coyotes.

These are just a few examples of the ways you can make your sets selective and avoid non-target catches. Study BMP documents for the species you trap to learn more.

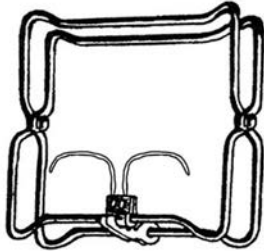
Explain how trigger adjustments on body-gripping traps can increase selectivity

Trappers bend the triggers on body-gripping traps as needed to make them selective. Triggers can be shaped to allow "streamlined" otters to swim through large body-gripping traps and still catch beavers, which have bigger bodies. The following images show some common trigger shapes used by trappers.

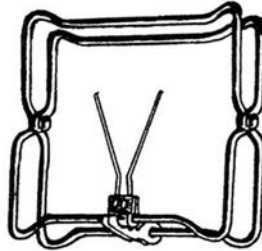


Trigger Adjustments

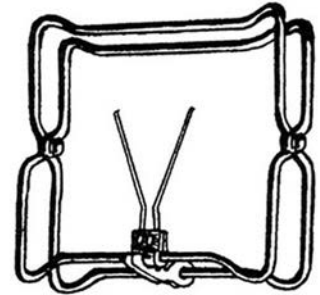
Note: Trappers often set body-gripping traps with triggers on the bottom to reduce pelt damage to the upper part of the pelt



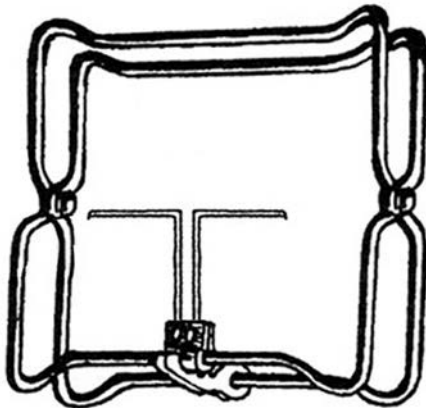
Small - for Mink



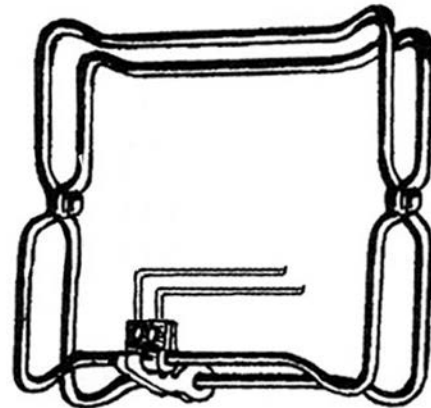
Small - for Muskrats



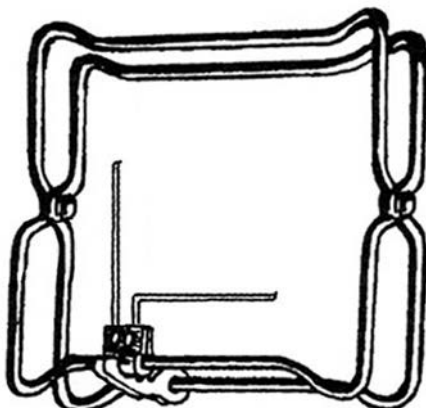
Medium - for Raccoon and Fisher



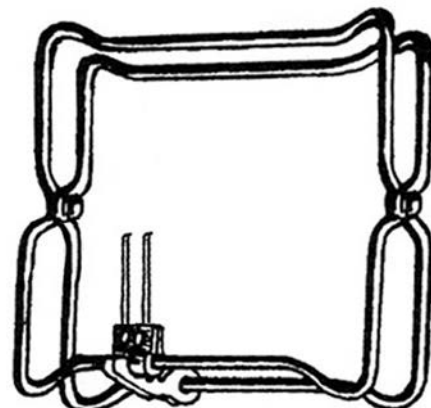
Large - Beaver and Otter



Large - Beaver, not Otter



Large - Beaver, not Otter



Large - Beaver, Not Otter
Note: triggers are cut short

Chapter 10

Water Sets



Ohio DOW Photo

Reasons to start with water sets using kill-type traps and techniques

No need dispatch

Reduces chance of catching a non-target animal

Less chance an animal will escape

Content Standard - *Students demonstrate an understanding of the procedures for making safe, effective, and selective sets in or near water*

Introduction

Beginning trappers should focus on water sets for muskrat and mink. This is an excellent way to catch some fur with minimal equipment while gaining knowledge and experience.

Water trapping saves on startup expenses and avoids most non-target animals. It also avoids the need to dispatch animals held in footholds or other live-restraining devices. When a trapper becomes skilled at trapping muskrats and mink, additional equipment can be purchased to use for larger furbearers such as fox, coyotes, raccoon, beaver, and otter. Generally equipment used for these furbearers is more expensive than the small traps used for muskrat and mink.

Explain the benefits of using traps that meet best management practice (BMP) specifications for water sets

Trappers, biologists, veterinarians, and researchers have evaluated many traps. BMP traps have been tested for:

- Animal welfare
- Efficient ability to capture and hold animals
- Selectivity for furbearers
- Practical use in the field
- Trapper safety concerns



Describe three reasons new trappers should start with water sets using kill-type traps or submersion trapping techniques

Body-gripping traps of suitable size or foot-holds in a submersion set should be used whenever possible for water trapping. Colony traps and cable devices are also used for water sets.

It is beneficial for beginning trappers to start with water sets as they are easier to make than dry land sets. Due to the location of the sets, water trapping is selective for semi-aquatic species and avoids most non-target animals.

The use of body-gripping traps and properly made submersion sets results in a furbearer's death. This prevents trappers from having to dispatch animals. Additionally, these sets make it unlikely that a furbearer will escape.

Submersion sets are frequently called "drowning sets," but semi-aquatic furbearers (muskrat, mink, river otters, beaver, and nutria) cannot take water into the lungs so, technically, they asphyxiate.

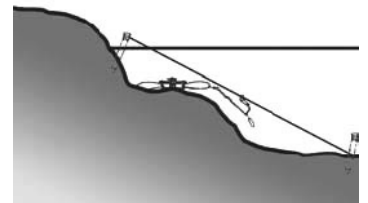
Describe two basic techniques for making submersion sets

Use submersion trapping techniques whenever possible for aquatic furbearers such as muskrat, mink, beaver, nutria, and river otter. Two techniques for making submersion sets with foothold traps are:

- Sliding wire technique
- Tangle stake technique

Small body-gripping traps are good choices for trapping muskrat and mink in shallow water. Set body-gripping traps at the entrance to a muskrat den, in a muskrat channel, or at the entrance to a pocket you create in the bank.

Guarded foothold traps are sometimes used for muskrat trapping where kill-type traps are not useable and the water is too shallow for a submersion set. The guard is designed to prevent muskrats from escaping.



Silvertip Productions

Submersion Set - Before the set is finished push the stake the rest of the way into the ground at the water's edge to keep the animal from tangling on the stake.



Ohio DOW Photos

Sliding wire anchor - You can use a heavy object or a stake to anchor the sliding wire in deep water

Water Sets



Ohio DOW Photos

Anchor in deep water



Attach wire to stake



Drive stake in all the way



Place the trap in position



Muskrat Hut

Some states restrict trapping near muskrat lodges. Know the regulations for your state.

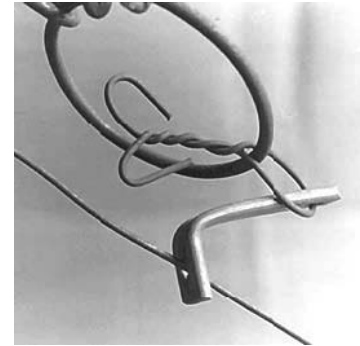
The sliding wire technique allows you to take advantage of a furbearer's instinct to swim toward deep water to escape. Make the set as follows:

- Attach a sliding lock to the end of your trap chain;



Ohio DOW Photo

Make sure the sliding lock points toward the deeper water



Ohio DOW Photo

The lock will prevent the animal from swimming back

- Use a heavy object such as a rock for an anchor, or use a stake you can push into the stream bed in deep water;
- Attach a wire to the anchor or stake;
- Put the anchor or the stake in water deep enough to fully submerge the furbearer you are trying catch;
- Bring the wire to the shoreline; put the sliding lock on in the correct direction, so that it will slide down the wire toward deep water but not back the other way;
- Attach the free end of the wire to a stake; drive the stake in the bank near your set; the slide wire should be tight;
- Make your set.

When the animal is trapped it will swim to deep water and be pulled under in a short time.

You can make a tangle wire set as follows:

- Tie a length of wire to a long stake;
- Attach the trap chain to the wire;
- Stake the trap securely in deep water, put another stake on the deep



side of the first stake;

- When the animal swims the wire will force it to swim in a circle, wrapping the wire around the two stakes; the weight of the trap will soon pull the animal under.

A special muskrat trap, called a colony trap, is also used for submersion sets.

Explain or demonstrate the procedures for making three common water sets and name the furbearers that can be captured in them

Runway Sets

When muskrats travel back and forth in shallow water they create a runway in the mud. Colony traps are a special type of cage trap designed to catch muskrats in a runway and keep them submerged. You can catch several muskrats at a time in a colony trap. There is a swinging door on each end. The door opens easily when a muskrat travels the runway. The door falls closed after the muskrat enters. Make certain the water is deep enough to keep the muskrats from sticking their noses out the top of the trap to breathe. During cold weather water levels may drop a bit at night because some water sources may freeze. In this situation, make sure colony traps are a few inches below the daytime water level. Body-gripping traps are also used in runways.

Pocket Set

A pocket set is one of the most effective water sets for muskrats and mink. To make a pocket set, find a bank that is straight up and down. At the waterline start digging a pocket into the bank at a level where the bottom will be about two inches below the water. The pocket should extend one to two feet into the bank and angle up. Put the bait or lure above water level at the back of the pocket.

The pocket should be about six inches in diameter for muskrat or mink. Set a body-gripping or foothold trap of the correct size for the animal you plan to catch.

The trap can be placed at the mouth of the hole in case the animal doesn't want to go all the way inside. If you are in an area where dogs may be a concern do not use meat or fish bait, or raccoon gland lures. To avoid dogs you can place the trap well inside the pocket, or make the set under cover such as low-hanging branches or exposed tree roots.



Ohio DOW Photos

Colony trap in runway



Dig pocket at water line



Shave bank on both sides



Put bait in pocket

Chapter 10
Water Sets



Ohio DOW Photos

Place trap at pocket mouth



Narrow place for a trail set



Cubby - Make the sides first



Make the top of the cubby

Trail Set (Blind or Natural Set)

Furbearers use the same trails at the water's edge on a regular basis. Find a narrow spot on the trail to make your set. If you don't find a natural place for a trail set use logs or rocks to narrow the path.

Dig a shallow depression in the bank at the narrow spot. Set a foothold trap in the depression, bedding it firmly into the mud. Use the sliding wire or tangle stake technique to make it a submersion set.

You do not need to use lure or bait on a trail set. Trail sets are effective for muskrat, raccoon, mink, beaver, and otter.



Dig a place to put the trap. Note the log placed to guide animal to trap.



Put the trap in the depression. Use slide wire or tangle stake technique.



Bed trap so it doesn't wobble.



Ohio DOW Photos

Small sticks in water guide animal to trap.

Cubby Set

Cubby sets are used for mink and muskrats where the bank slopes too much to make a pocket set. If you find tracks on a sloping bank make a cubby out of rocks, logs, or old boards. Place your bait or lure at the back of the cubby. You can use your foot or a trowel to make a depression for your foothold trap



at the entrance to the cubby. Use a submersion trapping technique with a slide wire or a tangle stake.

Muskrat Den Set (Bank Hole Set)

Musk rats make dens on the banks of streams, rivers, lakes, and ponds just under the surface of the water. If you see chewed up pieces of vegetation floating on the water look for a den nearby. Musk rats also make lodges out of cattails or reeds in shallow water marshes. You will find openings around the base of the hut where you can make den sets.

Body-gripping traps are the best choice for den sets. You can place small sticks in the upper jaws of the trap to hold it in an upright position.

Climb Out Set (Feedbed Set)

Musk rats, beaver, otter, and nutria leave distinct trails, sometimes called slides, at the spot where they climb out of the water to feed. You can put a foothold trap just under the water where the slide enters. Use a tangle stake or sliding wire submersion rig. No bait or lure is needed.



Muskrat climb out



Set foothold in water

Float Set

Musk rats often climb onto floating logs. You can take advantage of this habit by setting traps on logs or homemade platforms.

Make float sets in water more than a foot deep. Use muskrat size foothold traps on a chain or wire. When the muskrat is trapped it will enter the water and the weight of the trap will pull it under. Place branches or sticks over the top of the trap to keep ducks or other birds from stepping on it.



Ohio DOW Photos

Place trap at entrance. Use bait or lure and submersion techniques with cubby sets



Muskrat Den



Den Set - Body-gripping trap



Den Set - Sticks hold trap



Ohio DOW Photos

Beaver scent mound



Beaver trap at scent mound



Channel set for beaver

Spring Run Set

The place where a spring run or small stream enters a larger body of water is a good place to trap muskrat, mink, or otter. Use a foothold trap and submersion techniques.

Obstruction Set

An obstruction set is a variation of a trail set. Look for a tangle of tree roots, log piles, or similar obstructions on the bank. Mink will enter the water at these points. You can bed a foothold trap in shallow water using a tangle stake or sliding wire submersion rig. No bait or lure is needed.

Scent Mound Set

Beaver make mounds of mud and mark them with castor. Hide beaver-sized foothold traps under 3 to 4 inches of water with a securely staked sliding wire submersion rig. If beaver are in the area and you can't find a scent mound you can make one. Mark it with castor lure. This set is most effective in late season.

Channel Set

Muskrat, mink, otter, and beaver follow paths under the water called channels. This is a good place to set a submerged body-gripping trap. These furbearers regularly enter confined spaces so they don't usually shy away from a body-gripping trap in their path.

Place the trap at the bottom of the channel. If the channel is too wide you can arrange sticks or brush in a way to narrow the path and guide the furbearer into the trap. Use a blocking pole across the top of the trap to make the animal dive below it. Stakes and sticks are used to anchor the body-gripping trap and position it correctly in the channel.

Open Water Beaver Set

An open water beaver set is made like a scent mound set, except that it is baited with fresh poplar or other food instead of castor lure.



Otter Latrine

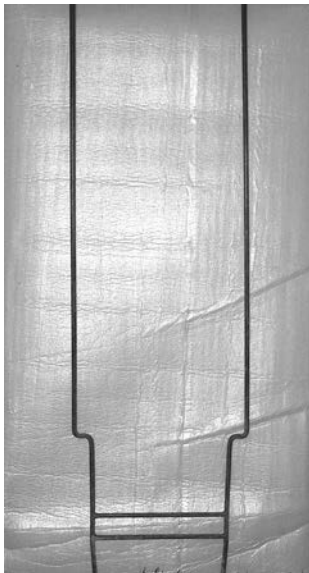
Otter regularly visit certain spots near the water called latrines. You will see piles of scat containing fish scales and bones at otter latrines. Set a foothold trap in 3 to 4 inches of water at the spot where the otter travels in and out. Use a sliding wire submersion technique.

Under Ice Beaver Bait Set

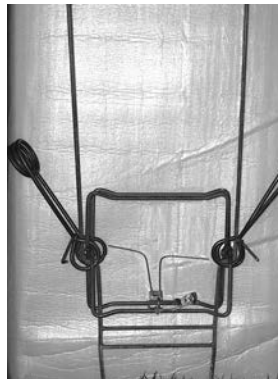
You can catch beaver under ice using foothold or body-gripping traps. Make sure the ice is safe and have someone with you when you make these sets in case you need help.

Chop a hole in the ice near a beaver den. Some states have a minimum distance the trap must be set away from the den, so check the regulations. Attach the trap and the bait to a long pole and push it deep down into the mud under the water. The pole should extend well out of the ice. A trapped beaver should not be able to reach the hole in the ice where it can breathe.

Examples of sets placed under water or under ice:



Stabilizer



Trap on Stabilizer

Many Trappers use stabilizers for body-gripping traps. Stabilizers save time, and avoid the need to cut poles and tie them together.



Ohio DOW Photo

Setting a blocking pole above a channel set - beaver

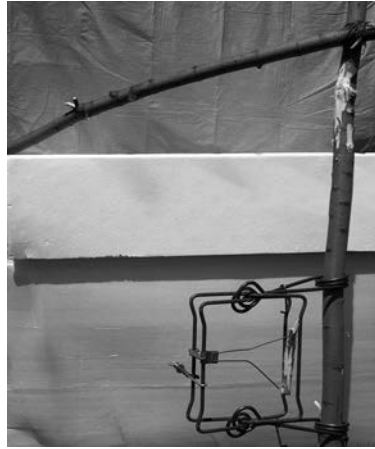
Making a set under the ice for beaver is not for beginners. Find someone experienced to help you. Always trap with a friend or family member, especially when you are using large body gripping traps and working on ice!



Raccoon in trap - This photo illustrates a desired strike of a body-gripping trap just behind a furbearer's head. This strike will result in immediate unconsciousness, and quick death.

Chapter 10
Water Sets

Use body-gripping traps with bent corners to reduce fur damage



Baited Body-gripping trap for beaver

Use a dry limb for the mounting pole or beaver may eat it. Use fresh poplar if available, for bait. The crosspole is lashed to the mounting pole above the ice to prevent loss of the trap. Change the bait to fish for otter.



Baited beaver set using a foothold

A small platform is attached to a large limb. The double long-spring is wired to the board. The trap chain is attached near the bottom of the limb to prevent the beaver from reaching the surface. A wire also runs from the chain to the crosspole above the ice.

Set body-gripping traps so that the trigger is on the bottom to reduce fur damage



Teepee set under ice for beaver

The teepee set is made on land and submerged under ice. It can be baited or placed in front of a bank den. Note that the trigger is set on the bottom. Many trappers do this so that the trigger wires will encounter a beaver's belly instead of the back. If fur damage from the triggers occurs, it is preferable for it to be on the belly side.



Underwater Sets



Body-gripping trap supports

Trappers can use sticks or poles to stabilize body-gripping traps in channels, or in front of dens. These photos show how to place the sticks. Sticks should always be placed inside the springs of jaws so they won't interfere with the jaws closing.

Sticks can also be placed beside traps to narrow a channel and guide the animal to the trap.

Always center a body-gripping trap in a channel or in front of a den. Beaver swim to the middle.

Some trappers twist wire triggers together in a straight line and center the trigger. This reduces the chance that a beaver carrying a limb will spring the trap prematurely.

Body-gripping traps with weak springs can cause fur damage

If an animal is frozen in a body-gripping trap, thaw it before removal to prevent fur damage

Chapter 11

Land Sets



Good Places for Land Sets



Ohio Dow Photos

Brush rows and Fencerows



Brush Filled Gullies



Near farm lanes that intersect
changing cover



Old Dumps

Content Standard - *Students demonstrate an understanding of the procedures for making safe, effective, and selective sets on land*

Introduction

Beginning land trappers should have considerable water trapping experience or help from an experienced mentor. You must know how to make selective sets, be prepared to humanely dispatch live animals, and know how to release non-target animals.

The dirt-hole set, flat set, post set, and cubby set are commonly used for coyotes, red fox, grey fox, raccoon, skunk, opossum, and other furbearers.

Know that land trap locations influence animal welfare and the selectivity of trap sets

Avoid setting traps near homes or places that are heavily used by people and their pets. Trappers should choose set locations that:

- Minimize exposure to domestic animals and human activities
- Prevent entanglement with fences or other objects that might result in injury
- Are selective to capture furbearers
- Avoid trails used by people

Explain the benefits of using traps that meet Best Management Practice (BMP) specifications for land sets

Trappers, biologists, veterinarians, and researchers have studied many traps. BMP recommended traps have been tested for:



- Animal welfare
- Efficient ability to capture and hold animals
- Selectivity for furbearers
- Practical use in the field
- Trapper safety concerns

Identify four good places to make land sets

Good places for land sets include:

- Brush rows and fencerows that guide animal movements and provide rodents, birds, or other food for furbearers
- Brush filled gullies that provide food and shelter
- Areas near farm lanes that intersect changing cover types or pass through brush rows
- Old dumps where furbearers such as raccoons and opossums hunt for food

Explain or demonstrate the proper use of stakes, cross-stakes, cable stakes, drags, and grapples for anchoring traps on land

Trappers must know how to anchor their traps properly to hold furbearers and prevent injury. Traps are normally anchored with stakes, but sometimes drags or grapples are used.

Steel stakes are recommended. Stakes must be long enough to hold the largest animal that may be caught. Under most conditions they should be 18-24 inches in length. Even longer stakes are needed in sandy soils. For fox and coyotes a more secure method is required to prevent the animal from pulling it out. You may need to use a double-stake swivel with the cross-staking method for a better hold. Cable stakes are another choice, but cable stakes take more time to dig out when you remove your set.



Ohio Dow Photos

Use steel stakes on land



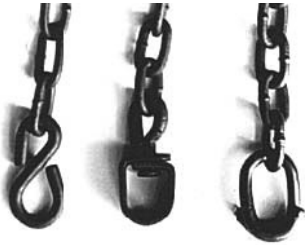
Cross-stake



Cross-stake fasteners

Chapter 11

Land Sets



Ohio DOW Photos

Stake Swivels/Fasteners

Bedding Traps



Dig bed slightly larger than trap and deep enough to put trap just below ground level



Put some loose dirt in hole and press trap into bed with slight twisting motion

In some terrain you may need to use drags or grapples. Drags and grapples allow animals to find cover nearby.

Shock springs are used on trap chains to help hold animals and prevent injuries. Use high quality shock springs of sufficient strength for animals you are trapping.

Swivels are important parts of your anchoring systems. Stake swivels and two or more chain swivels allow an animal to move freely without twisting the chain down to a point where it is easy for the animal to pull out of the trap.

Demonstrate the proper method for bedding a foothold trap at a land set

Traps must be properly bedded for land sets to work. Traps should be set level or slightly below the level of the soil around it. The steps for bedding a trap are:

- Dig a shallow hole
- Drive stake(s)
- Sift loose dirt into the bottom of the hole
- Press the set trap into the bottom of the hole
- Use the 4-point system to make sure it doesn't wobble
- Pack dirt around the outside of the trap

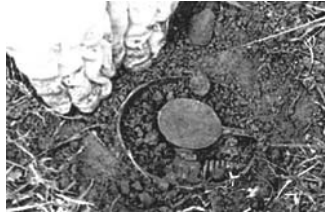
The 4-point system check includes:

1. Press on the loose jaw
2. Press on the other jaw
3. Press on a lever
4. Press on the other lever

If the trap is wobbly at any point pack more dirt under that area and repeat the 4-point check.



Packing dirt under loose jaw



Pack dirt around trap

Demonstrate the proper method for covering a foothold trap set on land

Generally, foothold traps set on land must be covered to hide them from furbearers. Dirt, leaves, and grass can be used to cover your traps. The covering must not interfere with the action of the trap.

Leaves and grass will work when you set a trap for raccoons or opossums, which are not as wary as fox or coyotes.

Make sure nothing gets under the trap pan, or the trap may not work. Likewise, make sure there are no objects above the jaws that might keep the trap from closing properly.

Crumple up a piece of wax paper and unfold it for a trap cover. Crumpling wax paper softens it so it won't make noise when the animal steps on it.

Use a dirt sifter to cover your trap without getting small sticks or stones in your set.

Explain or demonstrate the procedures for making three common land sets and name the furbearers that can be captured in them

Three sets every land trapper should know are the dirt-hole set, the flat set, and the cubby set. A post set is a variation of a flat set.

Dirt-hole Set

The dirt-hole set is popular with fox and coyote trappers but it will take other furbearers too. To make a dirt-hole set:

- Select a clump of grass or other natural feature for a backing at your set

Covering traps with dirt



Ohio DOW Photos

Cover pan with wax paper



Sift dirt over trap



You can cover land traps with a few leaves or grass for raccoon or opossums

Chapter 11 Land Sets

Dirt-hole Set



Ohio DOW Photos

1. Find some backing such as a clump of grass and dig a hole that slants back under it, putting the dirt in your sifter



2. Dig a bed for the trap in front of the hole



3. Stake the trap down in the middle of the bed

- Dig a small hole, about the diameter of a coffee cup, that slants back about 8 inches deep under the backing and put the dirt in your sifter
- Dig a bed for your coil-spring trap in front of the hole so the trap center will be about 7 inches from the hole for fox or 12 inches for coyotes
- Stake the trap down in the middle of the bed
- Set the trap and put it in the bed so that it is slightly below ground level
- Put a cover on the pan and sift the dirt on top

The hole by itself will attract a fox or coyote, but many trappers place bait in the hole. The bait should be about the size of a golf ball. If you use bait, cover it with some light vegetation. A furbearer will smell it, but the grass will prevent birds of prey from seeing it and landing in your set.

You can apply lure to the back edge of the hole and put some fox or coyote urine on the backing using a squirt bottle. Make certain you do not get any bait, lure, or urine on the trap bed.



4. Proper trap bedding



5. Place bait in hole



6. Put grass in hole to hide bait



7. Put lure on edge on hole and urine on backing



Flat Sets

A flat set is most effective for fox and coyotes, but it will take other land-dwelling furbearers too. The flat set is similar to a dirt-hole set, but no bait hole is dug. Instead, an attractor such as an old chunk of wood is used to get the furbearer's attention. To make a flat set:

- Place the attractor where a furbearer will see it
- Dig a bed about 6 inches in front of the attractor
- Stake the trap, bed it, and sift dirt over it
- Put a few drops of lure or a squirt of urine on the attractor

Post Set

A post set is made the same as a flat set, except that a broom-handle sized stick is used instead of an attractor. The post should be about 8 inches tall. Use lure or urine on the side of the post nearest the trap.

Cubby Set

The cubby set on land is made the same way as a cubby set for water trapping. Cubby sets are used for raccoons, opossums, bobcats, and other less wary furbearers. Cubby sets are generally not used for fox or coyotes. To make a cubby set:

- Build a cubby and make certain the back is secure so the furbearer will enter from the front
- Dig a bed for a coil-spring trap at the opening
- Bed the trap and cover it lightly with leaves or grass
- Place appropriate lure or bait in the back of the cubby

Additional Land Set Information

Enclosed Foothold Traps

Several types of enclosed foothold traps are on the market for raccoon trappers. These traps are highly selective for raccoon and opossum, which have small feet and long legs. Enclosed footholds have a small hole, with a trigger

Flat Set



Ohio DOW Photos

A chunk of wood makes a good flat set attractor

Cubby Set



Rocks can be used for cubby sets

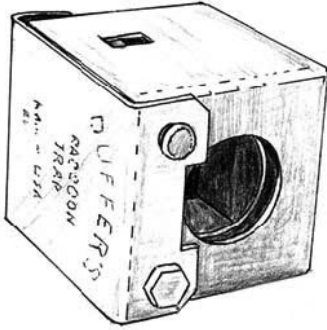


Bed the trap at the cubby entrance

Chapter 11

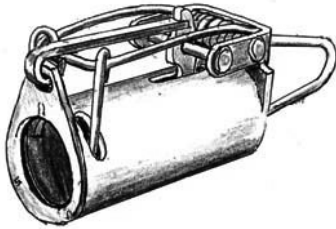
Land Sets

Enclosed foothold traps are selective for raccoons and opossums

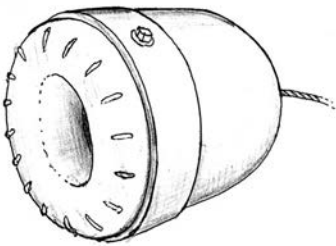


Joe Goodman

Duffer's™ Trap



Lil' Griz™ Trap



EGG™ Trap

Practice land trapping techniques before the season to hone your skills

fairly deep within the enclosure. Enclosed foothold traps are anchored and placed in the ground with baits attractive to raccoons. Selective baits attractive to raccoons include marshmallows, jam, honey, and anise. The bait is placed in the bottom of the trap, below the trigger. Larger animals cannot get their feet through the opening. Smaller animals cannot reach the trigger. When the raccoon attempts to remove the bait from the device the trap is triggered and a small spring arm captures the foot.



Duffer's™ Trap and EGG™ Trap



Duffer's™ Trap set in ground



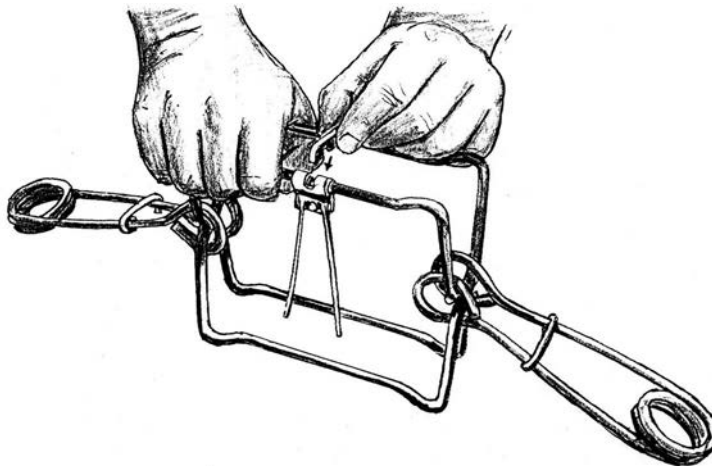
EGG™ Trap set in ground

Procedures for setting and using enclosed foothold traps vary. Some require disassembly and special tools. Some do not need to be placed in the ground. Enclosed foothold traps made of metal may be dyed to help conceal them and reduce the chance of theft. Some trappers prefer to leave them shiny as a visual attractant for raccoons.

Body-gripping Traps

The use of body-gripping traps on land is highly regulated. Even when legal, body-gripping traps should be used with care to prevent the capture of pets or non-target wildlife.

Body-gripping traps can be enclosed in boxes to prevent non-target animals from getting caught. Check the regulations for your state to see if this method is legal where you live. The size of the box, size of the opening, and placement of the box make this a selective method of trapping.



Joe Goodman

Using body-gripping traps on land



Medium size body-gripping trap for raccoon

This is a view of a body-gripping trap box during construction. Note the slots for the trap springs, and the wire hanging from the top. The wire will hold the bait. The back is covered with wood or wire mesh to keep the animal from reaching the bait without going into the trap.



Box Trap on Log

Some trappers set box traps on logs. Do not use this set in a location where dogs or cats will find the trap. Use sweet baits for raccoons. Raccoons often walk on top of logs.



5 gallon bucket

Trappers have developed several methods for setting body-gripping traps in plastic buckets to prevent non-target catches. Cut slots in the sides for the trap springs. Suspend sweet baits inside the bucket, above the trap. The small holes allow the scent to spread.

Practice safety when setting body-gripping traps - use setting tongs, safety latches, and a safety gripper.

Use sweet baits for raccoons to avoid non-target animals:

- Marshmallows
- Anise
- Honey
- Hard Candy
- Jam

Wooden boxes can be painted or allowed to weather so they blend in.

Some trappers camouflage their bucket while others prefer to leave them white as a visual attractant.

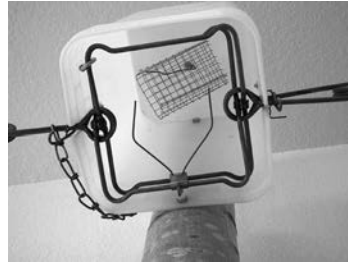
Chapter 11 Land Sets



Silvertip Productions

Wooden box for body-gripping trap wired to a tree. The box can be placed low to the ground, face down to prevent dogs from getting in. Dig a depression under the trap for an added attractant.

You can put this trap higher up the tree with the open end face up to avoid dogs.



Bottom view of square bucket

Check with your instructor, your wildlife agency, or a local furbuyer for details on safe, legal, and effective bucket sets that can be used in your area. This bucket is designed to mount on a tree.



Bucket with lid

Entry holes should be no larger than 6-7" for raccoons. Holes can be cut in the side, or the lid. Another option is to cover the opening with wire mesh that narrows near the entrance.



Bucket with wire mesh

Make certain the wire mesh will not interfere with the springs when they release.



Leaning pole set

Leaning pole sets are used for marten and fisher. A #120 body-gripping trap can be enclosed in a box, or set directly on the pole for marten. Use meat, fish, or strawberry jam for bait, and skunk essence for lure.

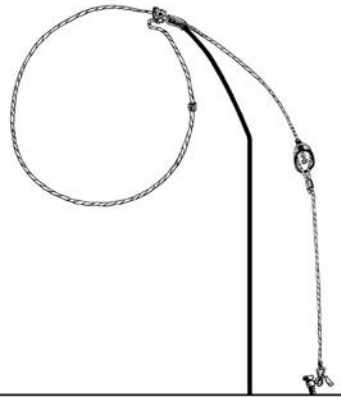


Leaning pole set

For fisher, use #160-#220 body-gripping traps baited with raccoon or porcupine meat. Use fisher musk, fisher urine, beaver castor or skunk essence for fisher lure. Make running pole sets under evergreen limbs to help keep snow from covering the traps.

Chapter 12

Cable Devices



From "Missouri Cable Restraint Training Manual." Copyright 2004 by the Conservation Commission of the State of Missouri. Used with permission.

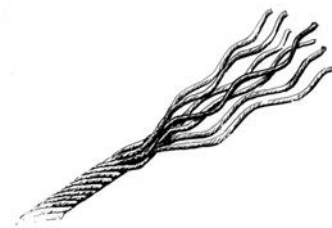
Non-Powered Cable Device

Content Standard - Students demonstrate an understanding of cable devices, and responsible techniques for using them

Introduction

Responsible trappers can use cable devices to make selective sets for many furbearers. Animals often travel the same trails and paths on a regular basis. Locations where the trail narrows are good places to set cable devices. Place cable devices correctly in the center of the line of travel, so the targeted furbearer will walk into it. Furbearers are accustomed to walking through weeds and brush, so cable devices do not alarm them.

Identify cable device equipment and materials



Natalene Cummings

Multi-strand steel cable - Used in modern cable devices

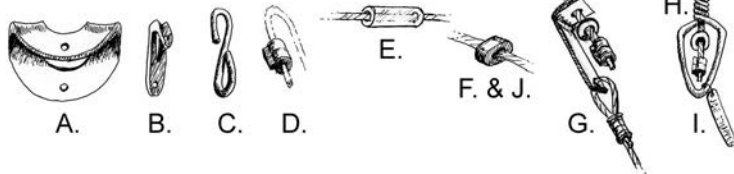
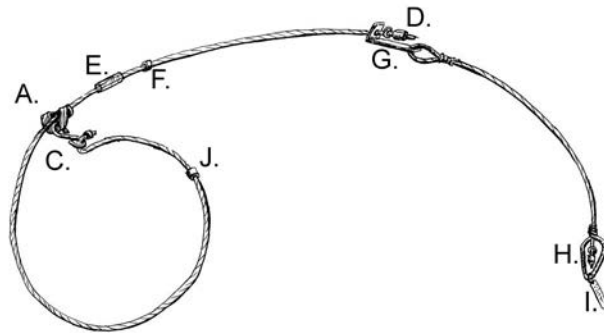


7x7 Cable



7x19 Cable

Natalene Cummings



Natalene Cummings

- A. Relaxing Lock
- B. Non-Relaxing Lock
- C. J-Hook Breakaway Device
- D. End Ferrule
- E. Stabilizer Tube

- F. Maximum Loop Stop
- G. Inline Swivel
- H. End Swivel
- I. Trap Tag
- J. Deer Stop



Cable Devices

Modern cable devices are made from stranded steel cable. Various sizes are used, but 3/32" is popular. State trapping regulations may require you to use a specific size of cable.

Non-Powered Cable Device

A non-powered cable device uses forward movement of an animal to place and close the loop on its body or neck.

Powered Cable Device

The powered cable device uses a mechanical feature, such as a spring, to place or close the loop of the cable on an animal's body or limb. An example of a powered cable device is the coil-spring activated Belisle™ Cable Device, which uses a foothold-like pan system to activate springs that place and tighten a cable around the captured animal's foot.

Relaxing Lock

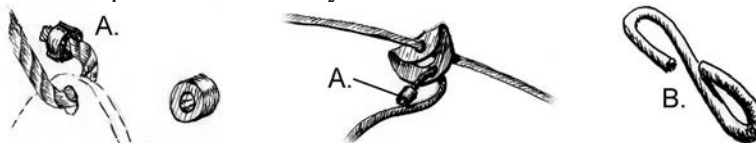
A relaxing lock will move in either direction on the cable. When an animal pulls against the device it tightens, drawing the loop smaller. If an animal does not pull against the device, it relaxes. Animals can be released unharmed from cable devices with relaxing locks set as restraining systems on land. Many types of relaxing locks are available. Some relaxing locks are made to break at a given strength, allowing larger animals such as deer to escape.

Non-Relaxing Lock

A non-relaxing lock keeps a cable from loosening after an animal is caught. It will close the cable loop tighter when pulled, but it will not relax when tension stops.

Breakaway Devices

In some live-restraining land set situations, trappers must use breakaway devices to allow deer, livestock, or other large mammals to escape. Breakaway devices are parts of a cable system that allow an animal to escape from the loop if the animal pulls against it with sufficient force. Ferrules, S-hooks, and J-hooks are examples of breakaway devices.

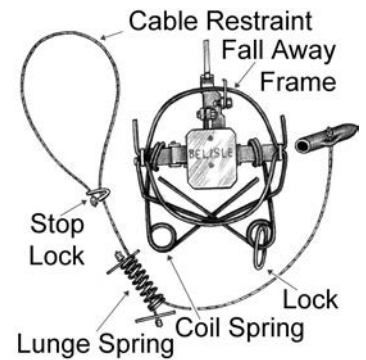


Natalene Cummings



Ohio DOW Photos

Cable swivel and ferrule



Joe Goodman

Unset Spring-activated Cable Device



Coil-Spring Activated Cable Device

Breakaway Devices

- A. Breakaway Ferrule
- B. Breakaway Hook

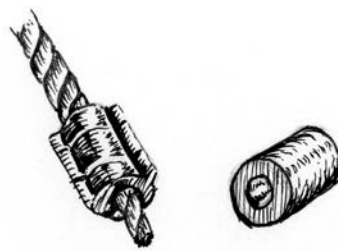


Natalene Cummings

Stops

Stops

Trapping regulations often require use of a “stop” to prevent a cable loop from closing below a certain diameter. Some trappers call them “deer” stops. Heavy gauge wire, steel nuts, or crimped ferrules can be used to make stops and maintain the cable loop at a minimum or maximum diameter, or both. The maximum loop stop prevents larger animals from entering the device. The minimum loop stop prevents the device from closing around a non-target animal’s foot. For example, if a deer steps in the cable loop the minimum loop stop keeps the cable from closing tight enough to hold it.



Natalene Cummings

Cable/end ferrule

Swivels

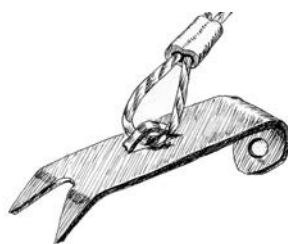
Swivels are used in cable device anchoring systems to keep the animal from twisting and kinking the cable.

Cable/End Ferrule

An end ferrule, also called a cable end, is crimped on the end of a cable to keep the strands from unraveling. A ferrule can also serve as a breakaway device.

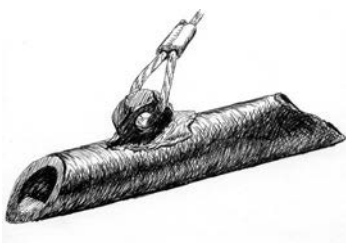
Anchoring Systems

Attach cable devices to steel stakes or earth anchors. An alternative is to pass a heavy gauge wire through a swivel on the end of the cable and make a loop around a tree. This allows a furbearer to circle freely around the tree without having the cable wrap up. Stakes and loops need to be strong enough to hold an animal that can pull against it using all four legs.



Natalene Cummings

Earth Anchor



Natalene Cummings

Earth Anchor



Commercial Double Stake



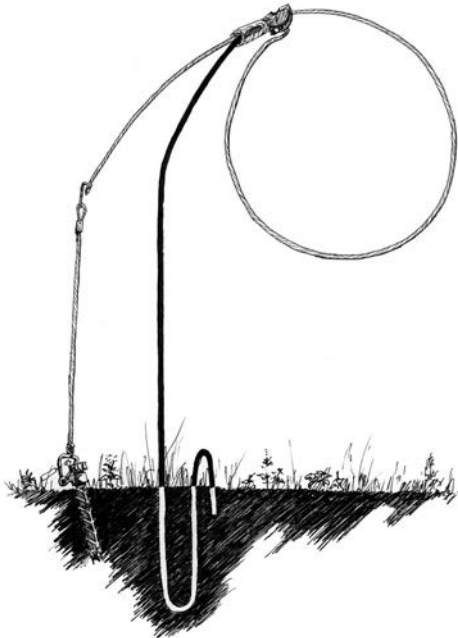
Natalene Cummings

End Swivel



Stabilizing Wire

Use a stabilizing wire, sometimes called a “pigtail”, to hold a cable loop in the proper position to capture a furbearer. Use 11 or 12-gauge wire for stabilizers. If the cable has a stabilizer tube it is simply placed over the wire. If not, the wire is bent in a manner to support the cable.



Natalene Cummings

Cable Device in Ground



Stabilizer



Tubing for Stabilizer



From "Missouri Cable Restraint Training Manual." Copyright 2004 by the Conservation Commission of the State of Missouri. Used with permission.

Loop Stabilizing Wire



Ohio DOW Photo.

Coyote Set

Cable Cutters

Use cable cutters to cut steel strand cable. It is nearly impossible to cut cable with pliers used for regular wire.

Explain the procedure for treating cable devices

Treat cable devices prior to use for three reasons:

- To reduce light reflection and visibility
- To remove undesirable odors
- To add natural scent to the device so the animal does not become suspicious



From "Missouri Cable Restraint Training Manual." Copyright 2004 by the Conservation Commission of the State of Missouri. Used with permission.

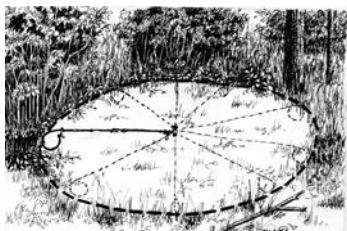
Coyote



Natalene Cummings
Pack Basket



Natalene Cummings
Coyote



Natalene Cummings
Restraint Circle - Should be free from entanglement

Boiling

Boil cable devices in water mixed with baking soda to remove the oil and dull the appearance. This makes the cable device less visible. Use 4 tablespoons of baking soda for every 12 sets of cable devices, along with enough water to keep the devices covered for one hour of boiling. After boiling add more water to the container until it overflows and drains the scum off the top. This prevents re-contaminating the cable devices with oil when you lift them out. Many successful trappers use cable devices prepared in this manner, but there are options if you want a darker appearance or some natural scent.

Some trappers boil cable devices a second time with a few logwood crystals for a darker appearance. Do not make cable devices too dark, or they will be too visible.

An option to using logwood crystals is to boil the cable devices in water with bark, moss, plant leaves, or spruce needles collected from your trapping areas. This will darken the cable devices and add some natural scent.

Handling and Storage

Use a strong wire to remove the cable devices from the hot water. Let them dry. Once the cable devices have cooled, you can handle them with gloves that are free of any scent. Hang the devices in a dry place where they will not absorb any unnatural odors.

Prepare enough cable devices to last you the season. Discard cables after capturing an animal. Cables will kink after a catch, and possibly weaken. A kinked cable will not close smoothly. Inspect all other parts of the cable device for damage or weakening before using them again.

Explain procedures for making selective sets using cable devices

Entanglement is a concern when setting cable devices. Animals caught in cable devices need freedom of movement. It is unlikely they will pull hard enough to hurt themselves, unless they tangle the cable on something. Set cable devices where there is no chance the animal can contact brush, fences, or other objects. Prevent the animal from reaching anything it could climb over, suspending it in the device with its feet off the ground. It is helpful to use shorter cables to prevent animals from reaching anything to cause a problem.

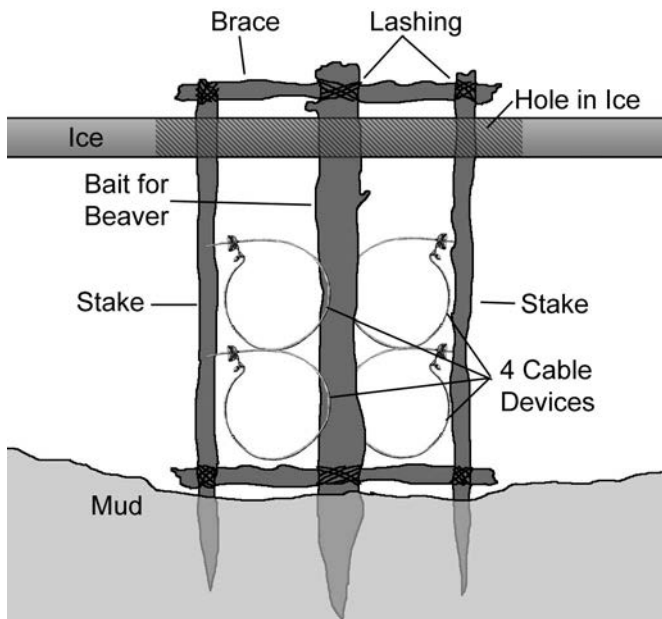


Make certain you thoroughly understand cable device regulations. Regulations vary from state to state according to furbearer management needs, and the need for selective trapping.

Using Cable Devices for Aquatic Furbearers

Cable devices can be set on land or in water. Trappers commonly use cable devices for beaver. Setting cable devices in water is one way to increase selectivity.

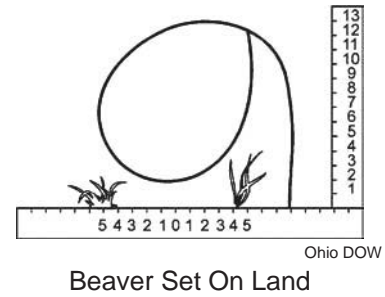
A careful trapper can make sets underwater using cable devices. The cables can be attached to stout poles and stuck in the mud to make channel sets or baited sets for beaver. During the winter, trappers can chop a hole in the ice and push poles through the hole into the mud with cable devices baited for beaver. The under ice beaver set is one of the rare times when bait is used with a cable device.



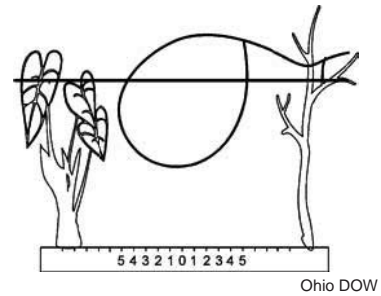
Cable devices can also be set as live-restraining traps in water and anchored on land. This will allow the furbearer to leave the water.

Using Cable Devices for Furbearers on Land

Set non-powered cable devices to catch beaver around the body. Set non-powered cable devices to catch fox and coyotes around the neck. Fox and coyotes have tapered heads that are wide behind the ears, so cable restraints around their necks will hold them well. Some powered cable devices are designed to place the cable loop on the animal's foot, others will place it around the neck.



Beaver Set On Land



Beaver Set in Water



Ohio DOW Photo

Set made on beaver trail

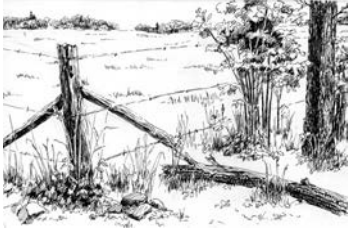


Natalene Cummings

Avoid setting cable devices in areas of high human or domestic animal activity.

Chapter 12

Cable Devices

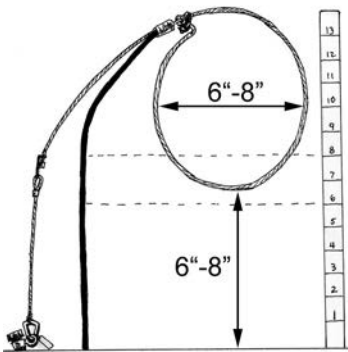


Natalene Cummings

Avoid setting cable device where animals can become entangled on fences, trees, rocks, or logs.

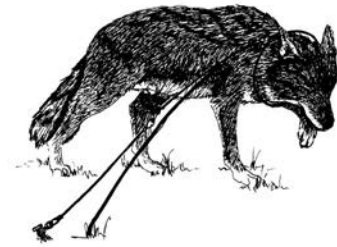
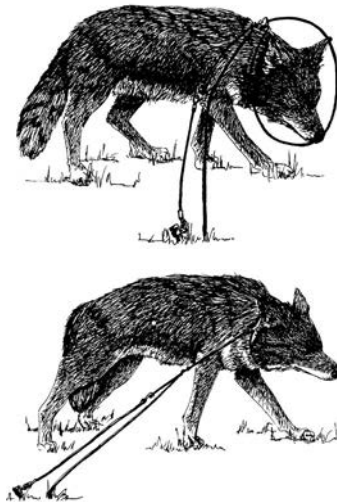
Do not set cable devices in trails used by people, domestic animals, or deer. To avoid deer, you can place a limb or pole horizontally immediately above your cable loop to make deer jump over the top. Keep the jump pole low or the deer will try to go under it instead of over it. Avoid using limbs or poles in a way that could create an entanglement problem for a captured animal. Do not anchor jump poles. Poles should easily fall out of the way when an animal is caught.

Cable devices work best in animal trails or blind sets where the animal will encounter it as it travels. Do not use bait or lure with non-powered cable devices on land. Places where the path narrows are best. Center the cable loop in the path. The size of the loop and the height from the ground to the bottom of the loop will help you catch the animal you want and avoid other animals.



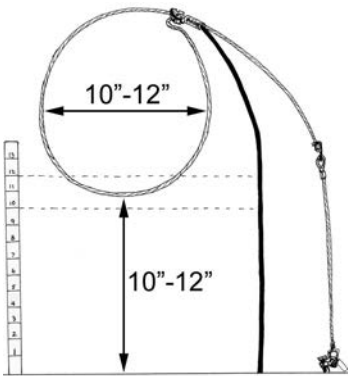
Wisconsin DNR

Fox Cable Device



As an animal walks forward, the cable loop closes

From "Missouri Cable Restraint Training Manual." Copyright 2004 by the Conservation Commission of the State of Missouri. Used with permission.



Wisconsin DNR

Coyote Cable Device

Loop sizes and heights

Fox cable loops should be 6 to 8" in diameter and the bottom of the loop should be 6 to 8" off the ground.

Coyote cable loops should be 10 to 12" in diameter and the bottom of the loop should be 10 to 12" off the ground.

Beaver cable loops set on land should be 9 to 10" in diameter and the bottom of the loop should be 2 to 3" off the ground.

Beaver cable loops set in water for swimming beaver should be 9 to 10" inches in diameter with 1/3 of the loop above the water line.

Chapter 13

Trapping Safety



Content Standard - *Students demonstrate an understanding of potential risks to their personal health, safety, and welfare from trapping activities*



Silvertip Productions

Develop safe habits around water and animals

Introduction

Trapping is not a dangerous activity, but there are risks related to weather, drowning, animal bites, and disease. Develop safe attitudes. Make safe behavior a habit.

Describe the conditions that cause hypothermia, symptoms of its presence, and treatment procedures

Hypothermia is a leading cause of death among people who enjoy outdoor recreation. Cold weather, wind, and water can lead to a loss of body heat. When your body temperature starts to lower, hypothermia sets in.

Shivering is one of the first signs of hypothermia. When this happens, go to a warm place, put on warmer clothes, or build a fire. Soon after shivering starts, a person may become confused, and clumsy. Watch for signs of hypothermia whenever you are outdoors in cooler weather. Even when air temperatures are in the 50's, hypothermia can occur.

Explain how to prevent hypothermia

Trappers can prevent hypothermia by wearing warm, dry clothing. Wool clothes are a good choice. Wool insulates even when wet.

Use hip boots or waders, plus long-sleeved rubber gloves when trapping in water. If you get wet return to home or camp and put on dry clothes.



Silvertip Productions

Hypothermia is a leading cause of death among people who participate in outdoor activities



Recognize the symptoms of frostbite and treatment procedures

Frostbite occurs when ice crystals form in your body's cells. It is a common cold weather injury to people's cheeks, ears, nose, toes, and fingers. Frostbite symptoms include white to grayish yellow skin and an intense cold, numb feeling. Pain and blisters may also be present. Protect frostbitten skin from further injury. Drink warm fluids, put on more clothes, or wrap up in blankets. The frozen area can be soaked in warm water (102 to 105 degrees F). Never rub frostbitten skin. Rubbing will cause further injury.

Frostbite is a common injury.
Don't rub a frostbitten area.
Warm it gently.

Recognize the danger of traveling on ice covered lakes, ponds, rivers, and streams

Avoid traveling on ice-covered streams and rivers. Water currents cause weak, dangerous ice. Ice on a pond or lake is usually more consistent, but be cautious. Springs, underwater structure, and other conditions can cause weak spots on lakes and ponds.



Silvertip Productions

Trapper Chopping Ice

Newly formed clear ice is generally the strongest. Some trappers consider three inches of ice to be the minimum thickness needed for one person to safely cross, but four inches is better. Six inches or more of strong ice is required for multiple people, or snowmobiles.

White ice, or ice mixed with snow and slush, is weaker than clear ice. Candle ice, usually found in the early spring, forms when good ice starts to decompose. Candle ice may be unsafe, even if it is two feet thick. Ice cleats can help you maintain safe footing. Carry a walking staff to help you check for ice conditions in front of you as you travel.

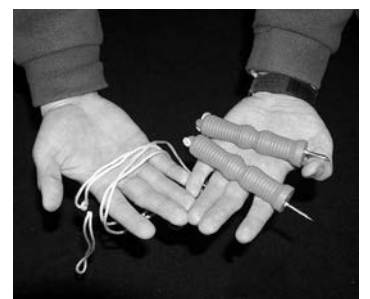


Silvertip Productions

Trapper fell through ice

Many trappers carry ice safety picks while working their traplines. Ice safety picks have strong handles with short spikes in the ends. The handles are tied together with rope. Thread the rope and picks through the sleeves and back of your coat so you will have them handy if you fall through. It is difficult to pull yourself out of the water without ice picks.

If you do fall through the ice try to climb out by facing the direction you came from when the ice gave way. When you get out, roll in the direction you came from when you fell through. The ice may be even weaker if you try to go a different direction.



Silvertip Productions

Ice safety picks

If a companion falls through, lie down on the ice to distribute your weight. Reach out to the victim with a walking staff, or throw them a rope. If you ap-



Silvertip Productions

Trapper wading in stream



Silvertip Productions

Trapper with canoe

proach too close you may fall in too.

After escaping from icy water build a fire immediately unless you are close to shelter or a vehicle where you can get warm. After falling into icy water hypothermia will set in quickly. If you have a cell phone with you, call for help immediately.

Recognize dangers related to drowning while wading or trapping near water

Trappers need to be aware of the danger of drowning. It is easy to slip and fall down a steep bank, or slip into deep water holes of rivers and streams when wading. It is difficult to swim when wearing waders or hip boots, or when your coat pockets are filled with heavy gear.

It is a good idea to wear an inflatable personal flotation vest when trapping around water. Good ones have a gas canister that can be used to inflate the vest instantly if you need it. The vest should also have a tube you can use to inflate it by mouth if the gas canister fails.

When wading, it is best to travel upstream because the water depth generally increases gradually. You are more likely to encounter steep drop-offs caused by currents when walking downstream.

Use a walking staff when wading to probe the water depth and bottom conditions. Smooth rocks or debris in the water can cause you to slip. You may encounter soft bottoms or hazardous conditions at points where two streams come together.

If you use a canoe or a boat for trapping follow all safety regulations. Take a boating safety education course.

Explain how to manage the risks for contracting diseases or parasites including rabies, West Nile virus, tularemia, Lyme disease, mange, and trichinosis

Wild animals can carry a number of infectious diseases that can cause human illness. Some diseases are specific to one or a few species of furbearers, while other diseases affect many species of wildlife. Wildlife diseases transmittable to humans or domestic pets should be of concern to anyone who regularly encounters or handles wildlife.

Safety - Animal Welfare - Responsibility - Furbearer Conservation



Infectious diseases can be caused by numerous organisms and may spread by direct and/or indirect contact with infected animals. Trappers can also be exposed to parasites associated with wild animals. Follow the recommended precautions to protect yourself from potential hazards. If you become ill make certain your doctor is aware of your trapping activity.

General precautions include:

- Wear latex or other protective gloves, eye protection, and protective coveralls when handling carcasses or scat
- Wash hands and arms thoroughly with soap and water after handling animals
- Clean and disinfect knives, skinning boards, cutting surfaces, and other equipment with a solution of 1 cup household bleach in 1 gallon of water
- Avoid sick animals or ones that do not act normal
- Do not drink untreated water from lakes or streams
- Cook all wild game thoroughly

Animal diseases and parasites that may affect humans include:

Rabies - Hydrophobia - Rabies is a virus that infects the central nervous system. Left untreated, rabies is always fatal. The rabies virus may be carried by all warm blooded mammals but it occurs most often among wildlife species such as raccoons, bats, skunks and foxes. Rabies is usually transmitted by the bite or scratch of an infected animal. Rabies can also be transmitted by contamination of a cut or scratch when skinning an infected animal, or from contact with your eyes, nose, or mouth.

Rabies occurs in two forms in wildlife; “dumb” and “furious”. In the dumb form the animal is lethargic and may suffer paralysis. In the furious form the animal is restless, aggressive, and may bite at real or imaginary objects.

If you are bitten by a wild animal wash the bite with soap and water, then seek medical attention. If possible, capture or kill the animal without damaging the head. Health authorities will test the brain tissue for rabies. Keep the animal refrigerated at 35 to 40 degrees F until it can be examined. Human Diploid Cell Vaccine (HDCV) can offer protection from the rabies virus without serious side effects. Ask your doctor for advice about HDCV, especially if you are trapping in areas where animals are known to carry rabies.



Silvertip Productions

Wear latex gloves



Silvertip Productions

Raccoons can carry several diseases

Trapping Safety



Center for Disease Control

Mosquitos may transmit the West Nile virus



Center for Disease Control

Tularemia thumb lesion caught from muskrat



FWS Photo

Cottontail Rabbits may carry tularemia

West Nile Virus - Most people who are infected with the West Nile virus will not have any type of symptoms. About 20% of people who become infected will develop West Nile fever. Symptoms include fever, headache, tiredness, and body aches. There may be a skin rash on the trunk of the body and swollen lymph glands.

The symptoms of severe infection (West Nile encephalitis or meningitis) include headache, high fever, neck stiffness, stupor, disorientation, coma, tremors, convulsions, muscle weakness, and paralysis. It is estimated that approximately 1 in 150 persons infected with the West Nile virus will develop a more severe form of disease. The incubation period is 3 to 14 days, and most West Nile fever symptoms last for a few days. Severe infection symptoms may last several weeks. Neurological symptoms or damage may be permanent.

It is best to prevent the West Nile virus by avoiding mosquito bites. Stay out of the field from dusk to dawn during mosquito season. Wear long sleeve shirts, long pants, and socks when outdoors. Use a mosquito repellent containing DEET on exposed skin. The Center for Disease Control advises that you should not use DEET repellent on skin under your clothes. Do not apply repellents containing permethrin directly to your skin.

Tularemia - Rabbit Fever - Tularemia is a bacterial disease most commonly associated with rabbits and hares. Beavers and muskrats may also carry this disease.

Tularemia is most commonly transmitted by the bite of blood sucking ticks or fleas. The bacteria enter the body, multiply, and invade internal organs. The liver and spleen enlarge and become covered with white spots. Humans can get tularemia from skinning infected animals, drinking contaminated water, getting bitten by infected deer flies and ticks, and sometimes by eating undercooked meat. Symptoms include fever, infected sores, swollen lymph nodes and flu-like feelings. These symptoms may become severe. With prompt antibiotic treatment, few cases of tularemia are fatal.

Lyme Disease - Lyme disease is a bacterial infection spread by the bite of a deer tick (*Ixodes dammini*). When diagnosed early the disease can be treated with antibiotics.

People get Lyme disease when they are bitten by ticks carrying *Borrelia burgdorferi* bacteria. Ticks that carry Lyme disease are very small and can be hard to see. If these tiny ticks bite mice infected with Lyme disease and then bite people or other animals the disease can be passed on. After several days or weeks the bacteria may spread throughout the body of an infected person.



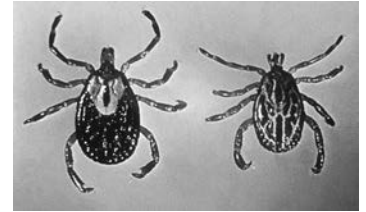
Diagnosis is difficult since Lyme disease symptoms vary and are similar to other common illnesses. One of the first symptoms may be a red circular skin lesion, but often the rash will not appear. Other early symptoms are flu-like and may include weakness, headaches, nausea, fever, stiff neck, dizziness, muscle aches, sore throat, and swollen glands. In advanced stages more serious symptoms may occur including facial paralysis, arthritis, and heart problems. Consult your physician if you have symptoms of Lyme disease.

Prevent Lyme disease by preventing tick bites. Wear light colored clothing when walking in tick habitat. Wear long sleeves and long pants. Check yourself thoroughly for ticks. If bitten by a tick remove it promptly and disinfect the bite with rubbing alcohol.

Leptospirosis - Leptospirosis is a bacterial disease that infects humans and animals. Almost all mammals can be infected, but it is more common in domestic animals than wildlife. The disease is known to infect striped skunks, raccoons, foxes, opossums, bobcats, muskrats and woodchucks. Leptospirosis spreads from eating infected food, contact with the urine of an infected animal, or contact with urine-contaminated water. The bacteria may enter the body through skin wounds, mucous membranes, or cuts. Leptospirosis bacteria multiply in the blood stream. It may affect the kidney and leave the body in the urine. Infection can cause flu-like symptoms in humans including headache, fever, muscle ache, vomiting, and kidney damage. Antibiotics are very effective for treatment.

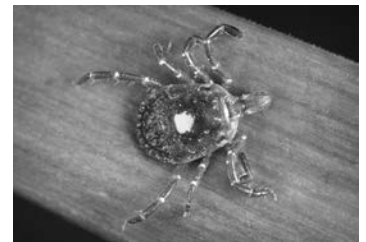
Rocky Mountain Spotted Fever - Spotted fever is a bacterial disease transmitted by ticks. Symptoms include a sudden onset of fever that lasts for 2-3 weeks, muscle pain, headaches, chills, and weakness. A rash may develop on the hands, arms, and legs and then spread to the rest of the body. Furbearers may carry the ticks that carry spotted fever. The disease occurs most often in the eastern half of the United States. Limiting exposure to ticks is the most effective way to reduce the likelihood of infection.

Sarcoptic Mange - Mange is caused by a parasitic mite. It occurs throughout North America and is most commonly found among red fox, coyotes, squirrels, raccoons, and domestic dogs. Adult female mites burrow under the skin and deposit their eggs. This makes the animal scratch, chew, or lick the infected area, which leads to inflammation and infection. When the eggs hatch the condition worsens. The animal's hair falls out. The skin thickens, and gets crusted with scabs, and cracks. Mange is nearly always fatal to red foxes, and sometimes to coyotes. The mite is transmitted among animals through direct contact or by contact with contaminated areas such as dens or burrows. People can get the mites by handling mange infested foxes, coyotes, or domestic dogs.



Center for Disease Control

Ticks that carry Lyme disease



Center for Disease Control

Lone star tick - carries Rocky Mountain spotted fever

Trapping Safety



NPS Photo

Beaver



FWS Photo

Raccoon



Center for Disease Control

Cotton rat - died from echinococcus

Trichinosis - Trichinosis is caused by eating raw or undercooked pork and wild game infected with a roundworm parasite called trichinella. It affects people and many kinds of domestic and wild animals. The parasite forms cysts in muscle tissue.

Cook furbearer meat thoroughly until the juices run clear. Freezing game meat, even for long periods, may not kill all worms. Likewise, curing (salting), drying, smoking, or microwaving meat does not consistently kill infective worms.

Giardiasis - Giardiasis is caused by a parasite that can be carried by many animals, including beaver. Beaver do not appear to be severely affected by the disease, but infected beavers can contaminate water sources used by people. Giardiasis spreads from drinking contaminated water or eating contaminated food. Human symptoms include diarrhea, cramping, weakness, and mild fever. The condition can last 1-2 weeks. Medication is usually prescribed to treat this ailment

Raccoon Roundworms - *Baylisascaris procyonis* is a common intestinal roundworm parasite found in raccoons and can cause a fatal nervous system disease in wild animals. The worms develop to maturity in the raccoon intestine, where they produce millions of eggs that are passed on with the feces. Released eggs take 2-4 weeks to become infective to other animals and humans. The eggs can survive for years.

Raccoons tend to defecate in specific places over a period of time. Likely places are at the base of trees, barn lofts, sand boxes, chimneys, attics, or on high surfaces such as rocks or roofs. People become infected when they accidentally ingest the eggs. The eggs can become airborne as dust where people can inhale them. When humans eat or inhale raccoon roundworm eggs, they hatch into larvae in the person's intestine and travel through the body, affecting the organs and muscles. Severity depends on how many eggs are ingested and where in the body the larvae spread. Symptoms can include nausea, tiredness, loss of coordination, and blindness. Infected animals may show signs similar to rabies.

Echinococcosis - (*Hydatid Disease*) - Echinococcosis is caused by infection with the larval stage of *Echinococcus multilocularis*, a microscopic tapeworm found in foxes, coyotes, dogs, and cats. Infection causes parasitic tumors to develop in the liver, lungs, kidneys, spleen, nervous tissue, or bone. The disease may be fatal. One form of the disease mainly affects wild animals including fox and rodents. Wild foxes, coyotes, and cats are infected when they eat *Echinococcus multilocularis* infected rodents such as field mice, or voles. Dogs can also be a host. Cats are less likely to develop Echinococcosis than dogs, but may also become infected. Once the animal is infected, the tape-



worm matures in its intestine where it lays eggs that are passed on in feces. The infectious tapeworm eggs are too tiny to see and will stick to anything.

People can get Echinococcosis by eating eggs in game meat or from contaminated food, water, or soil. Surgery is the most common form of treatment. Medication may be required. Use latex gloves when skinning animals and disinfect your work areas to prevent this disease.

Tapeworms and Other Parasites - People can get tapeworms and other parasites from contact with furbearer or dog feces. Keep your hands clean to prevent accidental ingestion of the microscopic eggs.

Other Viral Diseases - Pseudorabies, parvovirus, and distemper are diseases that can be carried by furbearers and passed on to pets or livestock. Have your pets vaccinated and seek treatment for them if you suspect these diseases.

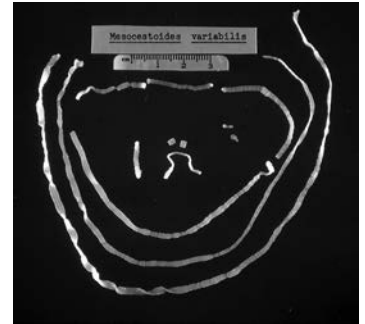
Recognize and manage the risks for being bitten or injured by wild or domestic animals

Animal bites and scratches can cause serious injuries. Wash wounds thoroughly with soap and water, apply bandages, and seek medical assistance. Keep the animal confined for observation if possible. If you can't confine the animal kill it without damaging the head so that health authorities can test it for rabies.

See the chapter on "Running a Trapline" for information on safe ways to release animals from traps to prevent bites and scratches.

Recognize the importance of making yourself visible to hunters

Trappers should make themselves visible to hunters. Wear hunter orange clothing, especially during hunting seasons where orange clothing may be required for hunters. Trappers have occasionally been wounded by hunters who fail to see the trapper, or hunters who fail to properly identify their target. Wearing blaze orange clothing will also make it easier to find you if you are lost, injured, or sick.



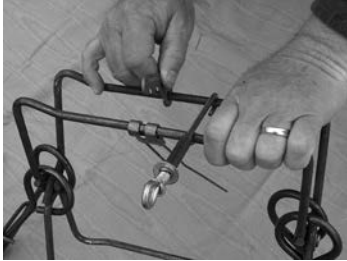
Center for disease Control

Tapeworms



Texas Parks and Wildlife

Bobcat



Silvertip Productions

Always use a safety gripper when setting large body-gripping traps

Firearm Safety

- Treat every gun as if it is loaded
- Control muzzle direction
- Be sure of your target & beyond
- Keep barrel & action clear of obstructions
- Unload firearms when not in use
- Never point a firearm at anything you do not intend to shoot
- Don't climb a fence or tree, or jump a ditch with a loaded gun
- Never shoot at a flat, hard surface or water
- Store firearms & ammo separately
- * Avoid alcoholic beverages while hunting or trapping

Recognize and manage the risks of setting large body-gripping traps for beaver

Some traps, such as large body-gripping traps used for beaver, can be dangerous to a trapper who doesn't know how to use them. If you are accidentally caught in a large trap you need to know how to release yourself, which may be difficult if you can't use one of your arms. Large body-gripping traps are most often set under water. You can drown or die from hypothermia if you get caught in a large trap set underwater.

When using large body-gripping traps carry setting tongs and a length of rope with a loop in the end. Keep it in a pocket where you can easily reach it with one hand. If you are caught, thread the rope through the ends of the springs. Put your foot in the loop and use your free arm to pull the loose end. This releases the pressure on the springs so you can free yourself.

Describe the rules of firearm safety that apply to trapping

Many trappers carry firearms to shoot animals caught in traps. Take a hunter education course to learn about firearm safety. Practice safe habits around firearms at all times.

When trapping it is generally a good idea to keep your firearm unloaded until you need to use it. It can be difficult to maintain control of a firearm when you are carrying gear and making sets.

When you shoot a firearm at an animal in a trap be careful about ricochets off the trap or rocks. If you are trapping with companions, everyone should stand behind the shooter.

Always look beyond your target when shooting a firearm and only shoot if it is safe. Keep the muzzle under control and pointed in a safe direction at all times, even when the gun is not loaded.

Know the importance of carrying a map and compass when trapping

It is easy to get lost if you are in unfamiliar territory. When you are looking for sign and places to make sets you may not be paying close attention to landmarks and trails. Always carry a map of the place you are trapping, and a compass. Many people carry a global positioning system (GPS) unit. If you



carry a GPS, make certain you know how to use it. Carry a compass for a backup.

Explain important rules for survival including the use of a buddy system, the need to tell someone where you are going and when you plan to return, the value of a wireless phone, and the need to carry matches or firestarters

Although many people trap alone it is best to use a buddy system for any outdoor activity. That way if you are injured or sick your buddy can assist you, or go for help.

Always tell your family exactly where you are going and when you plan to return. If you change locations or plans, let your family know. Leave a map of your trapline at home.

Wireless phones are a good safety tool for trappers. Do not rely on the phone to get you out of all situations though. You could be out of range or find yourself with a dead battery when you need your phone the most.

A trapper must know how to start a fire. Carry waterproof matches and firestarters with you at all times. If you find yourself in a hypothermia situation it may be difficult to start a fire without a firestarter

Explain the importance of wearing a seatbelt when traveling to or from trapping areas

Trappers need to be careful when driving. Wear a seatbelt. You may need to pull off the road in unusual places where other drivers are not expecting a car. Trappers develop a keen eye for observation, but you should not be intent on watching fields and other habitats when you are supposed to be watching the road. Hunters often say that driving to and from hunting locations is more dangerous than hunting activity itself. The same can be said for trapping.



Silvertip Productions

Use the "buddy system." It could save your life!

Buckle up!
Drive Safe!

Chapter 14

Running a Trapline



Content Standard - *Students demonstrate an understanding of the knowledge, skills, and attitudes needed to safely and responsibly harvest furbearing animals using best management practices*

Introduction

Your success on the trapline begins long before the season opens. Trappers need to obtain permission, scout properties, and prepare equipment before the opening day.



Ohio DOW Photo

Always ask for permission

Don't wait until trapping season opens to ask for permission

Explain the importance of obtaining permission to trap on private land before the season opens

Early summer is a good time to ask farmers and other landowners for permission to trap. During the spring, farmers are busy planting crops. In the fall, they will be busy again, preparing for the harvest.

Dress neatly when you ask a landowner for permission to trap. Be polite, even if the landowner denies your request.

When talking to landowners ask about possible problems with too many furbearers, or neighbors who might want someone to trap their property. If you establish a reputation as a responsible trapper you may find that landowners will call you and ask you to trap problem furbearers.

Contact landowners again shortly before the season opens. Ask about other people, such as hunters, who may be using the property. Let landowners know the days and times you will be on their property, and the type of vehicle you plan to drive. Make sure they have your telephone number in case they need to reach you.

Obtaining permission early will give you plenty of time for pre-season scouting. When scouting or trapping, treat the property and the owner with respect.



Describe the advantages of pre-season scouting

During pre-season scouting trips find specific places to make your sets and plan the materials you need. Make notes of what you find and sketches of areas that look promising. This will allow you to set your traps out quickly when the season opens.

If you wait until the season opens to scout it will be time-consuming and difficult to cover ground carrying your equipment. Scouting during the season may alert wary furbearers such as fox and coyotes. Pre-season planning allows you to make sets quickly and leave the area without creating much disturbance.

Make a commitment to check your traps at least once every day

When you set out a trapline, you assume responsibilities. Animal welfare is a top priority. Most furbearers are nocturnal so it is best to check your live-restraining traps at first light each morning. If you cannot check them at daylight, check them as early in the day as possible.

One important difference between trapping and hunting is your commitment to work your trapline every day until you remove your traps. Hunters can choose the days they want to hunt, but trappers must check their sets every day. Bad weather or other problems should not change your plans.

If you cannot personally fulfill your responsibility to wildlife and fellow trappers because of illness have another licensed trapper check your line. If a licensed friend or family member knows where your sets are located they can check or remove your traps for you. Keep notes and sketches showing where to find your traps.

State three or more reasons to check your traps early each morning

There are many good reasons to check your traps early each morning:

- Animal welfare
- Prevent escape from live-restraining traps
- Release non-target animals



Silvertip Productions

Pre-season scouting leads to success

Check your state trapping or furbearer regulations for information on how often you are required to check your traps. Regardless of the law, responsible trappers will visit their traps daily. It is good for animal welfare, and it will increase your success.

Why daily checks increase success!

- Less chance animals or traps will be stolen
- If traps have been disturbed you can remake the set
- Less chance for predation
- Less chance an animal will escape from a restraining device
- Less chance an animal will injure itself or damage its pelt
- If you remove an animal and set the trap again you may catch another one
- Most furbearers are active at night (nocturnal), so check your traps early each day

Running a Trapline



FWS Photo

Badger

Shooting Furbearers

Most trappers shoot animals in the head. Aim between the eyes and up a little for a brain shot. When you are certain the animal is dead, carry it a short distance away and lay him with his head downhill if possible. This will let it bleed out while you remake the set. Lay the animal on newspapers for the drive home. When skinning, you can wrap paper towels around the head and hold them with duct tape to contain any additional blood. Remove the towels after skinning and rinse off any blood with cold water. Hang the skin in front of a fan overnight to dry it.

Use selective trapping techniques to avoid catching pets

- Reduce chances of fur or trap theft
- Reduce chances of predation on your catch
- Lets landowners and others know you are responsible
- Gives you time during the day or evening to skin or sell your fur
- Gives you time to remake sets

Animal welfare is the most important reason to check your traps early each morning.

Describe two ways to safely, quickly, and humanely kill a furbearing animal

Inexperienced trappers should focus on making selective water sets using submersion techniques or kill-type traps. This avoids the need to kill your catch.

Trappers who make land sets need to be able to safely and humanely kill animals, or release them.

Generally, the best way to kill a trapped furbearer is to shoot it in the head with a .22 rifle. If the animal has bitten someone, or if rabies is suspected, choose a heart shot. Always shoot skunks in the heart since the brain may harbor the rabies virus even if the skunk shows no signs of the disease. Trappers should be graduates of hunter education courses and follow all firearm safety rules on the trapline.

If you are not legally permitted to carry a firearm on the trapline due to age or other restrictions, you will have to use a different method. Strike smaller furbearers such as raccoon, opossum, and fox hard at the base of the skull with a heavy wooden or metal tool to kill or render them unconscious. Placing your foot over the heart and chest area and compressing these organs will lead to death.

Trappers must plan the method of dispatch prior to setting traps. Planning reduces stress on you and the furbearer.



Describe two ways to release a non-target animal from a foothold trap

Your personal safety is the top priority when you release an animal from a live-restraining trap. Your second priority is to release the animal without harming it. If you cannot do this on your own, get help.

The first step in releasing an animal is to restrain it without hurting it. Trapping equipment dealers sell catchpoles for this purpose. To use it, slip the noose over the animal's head and pull it down snugly so the animal cannot escape. Then you can use the pole to steer the animal's head away from the trap while you depress the levers or springs with your feet. When the animal's foot is free you can position yourself behind the animal and release the noose.

You should have no problems with birds of prey if you have properly covered flesh baits at your set. If by chance you do catch one of these birds examine it closely for injury. If the bird is injured contact a wildlife officer for help getting it to a rehabilitator. If you can release the animal unharmed you should cover it with a blanket or coat while you depress the springs on your trap. Be extremely careful. Birds of prey have strong talons and beaks that can cause serious injury. Once the foot is free remove the covering and allow the bird to fly away.

Do not attempt land trapping if you cannot safely and humanely release non-target animals.

Describe what to do if a domestic animal or a pet is caught in a foothold trap

If you catch a domestic animal, examine it for injury before releasing it. Although the animal may appear to be a pet, do not assume it will not bite. Carefully restrain any animal when you release it.

If a domestic animal is injured contact the owner or the landowner so they can take it to a vet for treatment. No one wants to lose an animal or have it live with a permanent injury that could have been prevented with prompt treatment. If you are worried about a dispute with the pet's owner the landowner may be able to help you resolve it.



Silvertip Productions

Noosing a bobcat. Releasing a large animal, such as a bobcat, is difficult. Some trappers use a large piece of plywood with a notch cut in the side. Keep the plywood between you and the animal. Put the notch over the animal's leg, then release the trap.



Silvertip Productions

Use selective techniques to avoid pets. If you do catch a dog or cat, release it and notify the owner.

Running a Trapline

Your goal is to make a few good sets, not to make a lot of sets

Practice set construction before the season opens - practice makes perfect

Ticks and Fleas

Coyotes and other furbearers may have ticks and fleas that carry bubonic plague. The Center for Disease Control reports 10 to 15 cases of plague a year in rural parts of the western U.S. If you catch an animal with fleas in the western U.S., handle the animal with latex gloves. Put the animal in a plastic bag immediately, spray generously with insecticide, and tie the bag shut. This will kill most of the ticks and fleas before they leave the body when it starts to cool.



Ohio DOW Photo

Rinse dirty animals in clean water

Three Reasons to Keep a Journal

- Increase your success
- Guide others to your traps if you get sick
- Save your memories to enjoy over the years

Compare the decision to make a few good sets for furbearers versus setting as many traps as possible

It is better to make a few good sets than to make many sets in a rush. Pre-season scouting and planning will help you make sets that have a high chance of success. If you rush your sets, they may be low quality and catch fewer furbearers. As you gain experience you can increase the number of traps you set.

Describe responsible fur handling procedures in the field and why it is important

Take great care handling your catch in the field. If an animal is wet and muddy, rinse it out in the cleanest water you can find. Remove the excess water by stroking the animal or gently shaking it. When you get the animal home, dry the fur as soon as possible.

When animals are trapped on land, keep them dry. Use a brush or comb to remove burrs or dirt.

Put any furbearers that are not bloody from shooting in a burlap bag or other protective cover. If an animal has fresh blood on its fur, lay it separately on newspaper or other material in the back of your truck or your car trunk. Be sure not to display animals in ways that may offend people who see them.

Care in the field shows respect for your harvest and it will make the skinning job go faster at home. Proper handling will help you get the best price for your fur.

State three reasons a trapper should keep a daily journal

It is a good idea to keep a journal. Over time, it will help you increase your catch and bring back many good memories. Make notes about the types of traps you use, how you make your sets, and how many animals you catch at a set before you remove it. Keep notes about different lures or baits you use. Soon your journal will help you know how to make your sets work the best during different parts of the season.

A journal is also a good place to keep sketches and information about your sets. Remember, sketches will help someone else find your traps if you get sick or cannot run your line.

Chapter 15

Using Furbearers



Content Standard - *Students demonstrate an understanding of the full value of harvested furbearers*

Introduction

Responsible trappers make full use of furbearers they harvest. The value of a pelt for clothing is obvious. Furbearers are also used for human food, pet food, glands, skulls, and fertilizer.

Know the advantages, disadvantages, and procedures for four ways to sell furbearers or pelts

Fur harvesters have four choices for selling fur. There are advantages and disadvantages for each method. Options include:

- Local furbuyers
- Traveling furbuyers
- Selling by mail
- Fur auctions

Local furbuyers will know the most about furbearers in your area. They can be a valuable source of information and experience.

If you live close to a furbuyer you can sell whole animals as you catch them. This is an advantage if you don't have a good place to process fur and store it. A local buyer can also give you specific tips on fur handling, or possibly show you the best techniques. Local buyers also buy "green" pelts. Green pelts are skinned but not fleshed, stretched, and dried.

If you are fortunate enough to live near several furbuyers you can shop around for the best price. This is generally best if you have a large number of furs. A disadvantage of selling to a local buyer is price. A local buyer is a "middle man" who must buy low and sell high to make a living.



Silvertip Productions

Beaver caught in a body-gripping trap

Taxidermists often look for high quality specimens to mount

Check regulations

Animals with unusual pelts, such as albinos, may bring top dollar from taxidermists, but little from a furbuyer. The same may hold true for lesser-trapped species, such as ringtails.

Safety - Animal Welfare - Responsibility - Furbearer Conservation



Traveling furbuyers work for larger companies. You may be able to meet them at a local sporting goods store on scheduled dates, or make an appointment for them to visit you. Traveling buyers make it convenient for you to sell fur, but the price you receive may be lower than the price you could get selling by mail or at auction.

Some trappers sell their fur by mail. Mail buyers advertise in trapping magazines. Selling by mail saves you the time and cost of driving a long distance. Mail buyers will usually make payment in a few days. Mail buyers do not charge a commission, and some will pay the shipping costs. Some will also give you 10 days or so to decide if you like the offering price. If not, they will return your furs.

Price lists for mail buyers can be deceiving. Prices can change, or a buyer may give you a good offer for some of your furs and downgrade the rest. When selling by mail you lose the advantage of having competitive bidding for your fur.

Fur auctions are another option. Your fur may bring a higher price at an auction if there are a large number of buyers. Commissions paid to buyers or auction houses will reduce the money you receive. Fur prices can change during the season. Top offers at an auction may be less than the offer you could have had from a local buyer if the price drops while you wait for the auction.

Each trapper must decide when and how to sell fur based on current prices, price forecasts, convenience, and cost. Other trappers, magazines, and trapping associations can provide helpful information. The more you know about grading fur and market conditions, the better the chance you will earn a good price for your work.

Know that furbuyers will grade animals or pelts by primeness, size, color, texture, fur density, damage, and other characteristics

Furbuyers grade pelts by a number of factors before offering you a price. Pelt size, primeness, fur density, color, texture, and damage affect the grade.

Larger sized animals of one species generally bring a better price than smaller ones. Pelt primeness is a major grading factor. Trapping seasons are set to harvest furbearers when they are prime, during winter. Summer pelts are thin, flat, and have little to no value. Prime pelts have dense underfur and fully developed guard hairs. The skin, or leather, side of an unprimed pelt is dark blue or black because the hair follicles are not fully developed. Later in the



Silvertip Productions

Fox pelt on stretcher



FWS Photo

Fox furs

Running a Trap Line



Silvertip Productions

Trapper bagging fresh muskrat for freezer

season furs may not be worth as much because of fading color, hair loss, rubbing, or curling. Furs can also be damaged by careless handling.

The best pelts are graded as “Ones” (I) or “Ones part Twos” (I pt. II). Seconds are lower quality due to slight damage, color, or other factors. Thirds (III’s) are badly rubbed. Unprimed and fourths (IV’s) are of very little, if any, value.

Know that meat from some furbearers can be used for human consumption

Many people enjoy eating meat from healthy beaver, muskrats, raccoons, nutria, opossums, and bobcats. Freshly caught, skinned, and gutted animals will taste the best. The front and hind quarters and back meat are most commonly eaten, while the rib-cage area is usually thrown away. Avoid meat from any animals that appear sick. Keep the carcasses clean and thoroughly cook any wild game you intend to eat.

Know that meat from some furbearers can be fed to dogs or used for food at mink farms

Some trappers feed muskrat and beaver meat to their dogs. Check with your veterinarian to see if furbearer meat would be a good choice for your dog’s size, breed, age, and general health. Fur ranchers may buy muskrat and beaver carcasses for mink food.

Know that glands from some furbearers can be made into lure or sold for commercial use as perfume

Castor glands and oil sacs are found below the skin in the anal area of both male and female beaver. Castor glands and oil sacs are valuable and can be removed. Trappers can sell the glands for use in perfume or trapping lure.

Mink, weasel, skunk, otter, and fisher have anal glands that contain a strong musk useful in making trapping lure. The glands should be cut loose with minimal squeezing and kept cool or frozen. Weasel glands are particularly good for attracting mink, otter, weasel, fox, and coyotes.

Fox and coyote anal glands and foot pads are used in lure making for those species. Glands of raccoons, opossums, badgers, and muskrats are sometimes used too.



Beaver castor glands



Know that furbearer skulls are sometimes needed for science classes or nature interpretation

Furbearer skulls are often needed for science classes or nature centers. Dermestid beetles are useful for cleaning skulls or other bones you want to save.

Describe why it is important to properly dispose of any animal parts that remain after processing

Responsible trappers use as much of each animal trapped as possible. Any remaining parts should be taken to a rendering plant, used for fertilizer, or buried. Improper disposal could lead to human or animal health problems. Other people could be offended by seeing animal carcasses and parts. Disposal methods may be regulated in some areas.



Silvertip Productions

Beaver skull

Chapter 16

Handling Fur



Ohio DOW Photos

Fur Handling Tools
Comb, Brush, & Fork



Knives



Knife Sharpeners

Content Standard - *Students demonstrate an understanding of the knowledge, skills, and equipment needed to safely skin animals and prepare the pelts for market*

Introduction

Proper fur handling is the key to getting a good price for the furbearers you worked so hard to trap. Furbearer carcasses can spoil quickly, especially in warm weather. If you don't know how to skin and prepare pelts you may want to consider selling your furs unskinned on the carcass. To avoid spoilage, a good rule of thumb is to sell unskinned animals daily if the outside temperature is above 40 degrees, every two or three days if below 40 degrees. Selling your pelts on the carcass is less work for you and more work for the buyer. You will receive a lower price for unskinned furs. If you do decide to skin your own catch, proper fur handling begins at the trap site.

If a furbearer is trapped in water it should be removed from the trap and rinsed clean of any dirt, mud, or vegetation. Shake excess water from the animal, and stroke it from head to tail with your hand to remove as much water as possible. If dry snow is available, the animal can be rolled in it to absorb water. If it is below freezing don't lay a wet animal on ice or a metal surface. The guard hairs of the pelt will freeze to ice or metal, damaging the pelt when you pick it up. If an animal's fur is still wet when you get home, hang it up by the head or forelegs in a cool place to dry. Circulating air with a fan will decrease drying time. Generally, pelts should be dry before being skinned and placed on a stretching frame.

If a furbearer is trapped on land and is already dry, simply brush or comb the pelt to remove any burrs or dirt. Land furbearers may have external parasites such as fleas, ticks, or mites, so keep the carcasses in a place where they won't contaminate your house, clothing, or vehicle.



Explain the importance of wearing latex gloves when processing furbearers

Furbearers should be skinned as soon as possible after they are trapped. The pelt is easier to remove and less likely to be damaged when the animal is fresh. Before skinning, remember to put on a pair of latex gloves. The gloves will help protect you from any diseases the animal might be carrying.

Explain the terms “cased furs” and “open furs”

Pelts are prepared for the fur market by skinning in one of two ways: cased or open. Except for beaver and sometimes badger, all furbearers should be skinned cased.

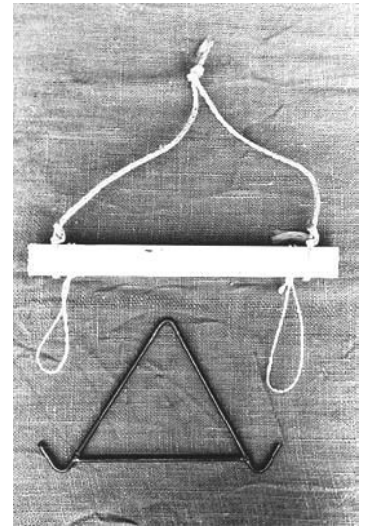
Case skinning is much like removing a sweater or sweatshirt by grasping the bottom and turning it inside out as you pull it up over your head. To do this with a furbearer pelt, make a cut from the top of the foot pad along the inside of one back leg to the top of the foot pad of the other back leg. Then simply remove the pelt from the carcass by turning it inside out, skinning down over the back legs, forelegs, and head.

To skin a beaver or badger using the open method, make a cut on the underside of the animal from its chin to the base of its tail. Removing the fur this way is much the same as you would take off a coat.

Explain the terms “market fur in” and “market fur out”

Fur buyers want cased-skinned, dried furs presented to them either “fur in” or “fur out,” depending upon the furbearer species. “Fur in” means that the fur side of the pelt is on the inside when the pelt is sold. “Fur out” is just the opposite; the fur should be on the outside of the pelt, the skin on the inside. Check with your local fur buyer to see how he wants each species of furbearer pelt prepared for market.

Most fur buyers are glad to explain proper fur handling techniques and preparation to you since it means more profit for both of you. Don't be afraid to ask.



Ohio DOW Photos

Gambrels



Silvertip Productions

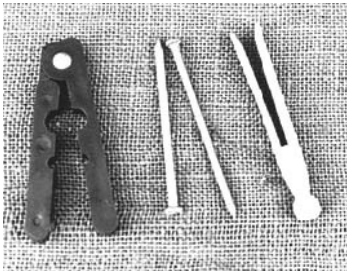
Skinning Beaver



Raccoon - cased pelt, fur in

Handling Fur

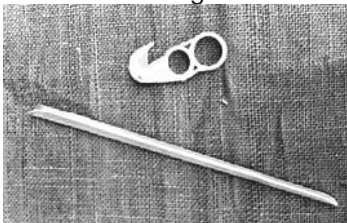
Tailbone Pullers



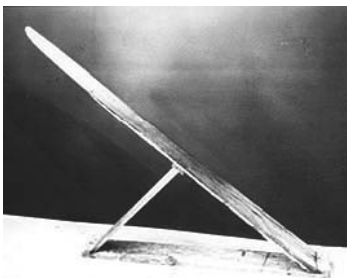
Ohio DOW Photos

Commercial model, nails, clothespins

Tail Slitting Tools



Top - Slitting Knife
Bottom -Metal Guide



Fleshing Board

Muskrat Tools



Muskrats do not have a lot of fat. They can be pulled over a scraping board and fleshed with a butter knife or a spoon

Explain why the tails of some furbearers are split and left on the pelt while the tails of others are removed

Furbearers with furred tails should have their tails split from the underside with a knife and the tail bone removed. A tail-stripper comes in handy for this purpose. The de-boned, furred tail should remain attached to the pelt. Tails of furbearers that are not furred should be cut from the pelt at the hairline during skinning and discarded.

Know the purpose of a fleshing board and fleshing tools

Once you've skinned a furbearer the next step is fleshing. A fleshing board is a narrow wooden or fiberglass beam that holds a pelt when removing meat or fat still on the skin. If not removed, this meat or fat could rot and spoil the pelt.

Once pulled onto a fleshing beam (skin side out), the pelt is scraped with a double-handled draw knife, a single-handled scraper, or other type of fleshing tool.

Draw Knife (below)



Spoon Scraper (right)

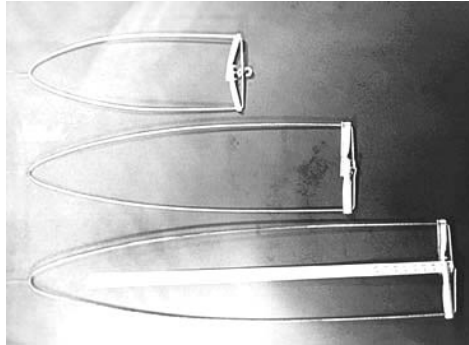


Describe the proper use of wire and wooden stretchers

The final step in preparing furs for market is to place the skinned, fleshed pelt on a wire or wooden stretcher. The term "stretching" may be a little misleading, as the pelt is not being stretched at this point in the process. Rather, it is simply being held in place as it dries so that it does not shrink or shrivel. Most cased-skinned furs should first be placed over a stretching board or wire frame fur-side in. Remember to center the pelt on the board or frame, meaning that the forelegs and belly of the pelt should be on one side of the frame and the eye holes, ears, and back should be on the other side. Pull the pelt snug, but not too tight. If you are using a wooden stretching board secure the pelt in place with a few tacks or push pins near the base of the tail and back legs. Wire frames usually have two metal arms with prongs that hold the base of the pelt taut.



Wire stretchers come in many sizes, and are most commonly used



Ohio DOW Photos

Beaver skinned open

Explain the process of drying pelts and why it is important

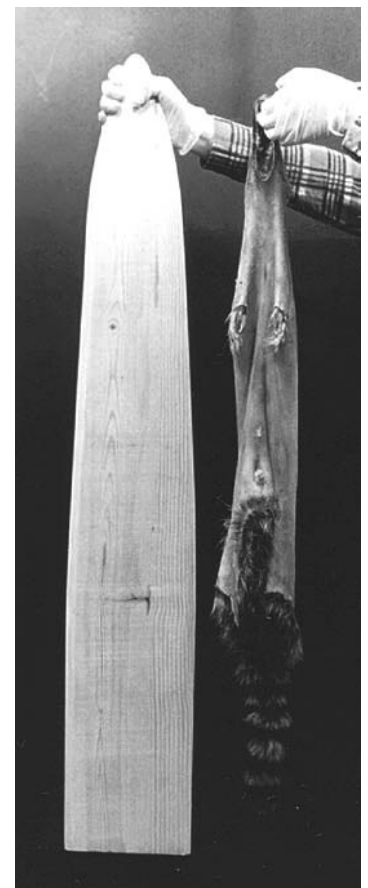
Once a pelt has been properly placed on a stretching board or wire frame it should be hung up and dried slowly in a room with a temperature of about 55 to 60 degrees Fahrenheit. Use a fan to circulate air throughout the room to decrease drying time. Pelts of wolves, foxes, bobcats, fishers, marten, weasels, and coyotes should be turned fur side out.

You must check the pelts as they dry fur side in. Once the skin is dry to the touch, remove the fur from the stretcher and turn it fur side out. Place the pelt back on the stretcher fur side out and pin it in place to finish drying. The skin may be dry to the touch in as little as one hour for weasels, to as long as 10 hours for wolves.

Complete drying of a pelt may take anywhere from just a few days to a week or more depending upon the temperature and air flow. Regardless of how long it takes, a pelt should be completely dry before removing it from the stretching board or wire frame. If not, the pelt could rot, and all the effort you put into catching, skinning, fleshing, and drying the fur will be lost.

Explain the process for freezing pelts

An alternative to stretching skinned pelts is to quick-freeze them. Care must be taken if you choose this method or the pelts could be ruined. Always freeze the pelt flat, fur-side out, with no exposed flesh. Do not roll furs, and never freeze or thaw your fur in plastic. Animals with heavy flesh such as coyote, raccoon, beaver, and badger should be thawed out for 5-6 hours in a cool room before selling. Never allow frozen green pelts to thaw for so long that the grease melts, or the skin gets slimy. Muskrat pelts should be frozen flat and not thawed at all before selling.



Wooden Stretcher



Turning a Canine Pelt

Handling Fur



Ohio DOW Photos

Stretching Canine Fur Out



Preparing to Skin a Beaver



Beaver on Board

Small furbearers such as mink and muskrat can be frozen whole, without skinning. Allow whole frozen animals to partially thaw before selling. In the case of selling whole frozen muskrats, only the feet need to be thawed when presenting to the buyer.

Individual furbuyers may have different instructions for freezing pelts or whole animals. If you know where you intend to sell your fur, check with the buyer for more specific directions on freezing fur.

Explain the procedure for “boarding beaver”

Beaver and sometimes badger are skinned open rather than cased. The pelt is then either tacked onto a plywood board, or sewn onto a wooden or metal hoop frame for drying. If tacked onto a plywood board (this should be done skin side up), use nails at least two inches long. Place the nails no more than one inch apart. The pelt should be shaped to form either a circle or oval. Once the pelt is tacked in place, raise it off the board up to the head of the nails in order to allow air circulation between the pelt and board. If sewing the beaver pelt onto a hoop, make your stitches about an inch apart. Regardless of whether you tack or sew, the four leg holes on the pelt should be closed, either by nails or stitching.



Tacking beaver to board



Lifting beaver pelt from board

Note: Experienced beaver trappers sometimes skin a beaver partly open, and partly cased. This makes it easier to hold the beaver on a fleshing beam. After fleshing they finish cutting the belly so they can board the beaver.

The following pages cover the steps taken to skin, flesh, stretch, and dry a raccoon pelt.



Ohio DOW Photos

1. Brush and comb the fur.



2. Lines show where to cut.



3. Cut both legs from ankle to vent, then around the ankles.



4. Cut bottom side of tail. Start about 1/4 of the tail length down. Wear latex gloves when skinning. Keep your knife sharp.



5. Pull the pelt off the legs, down to the crotch. Work it loose with your fingers, then cut it away at the crotch.



6. Pull the pelt off the hips then pull it away from the back and part way down the tail.

Chapter 16

Handling Fur



7. Remove tail bone with puller.



8. Once the tail is free, you can use the tail splitter, or the tip of a sharp knife to split open the tail.



9. Pull the pelt down to the animal's shoulders. Use a rag to get a good grip.



10. Work your fingers through the pelt at the armpit and pull the skin off the leg.



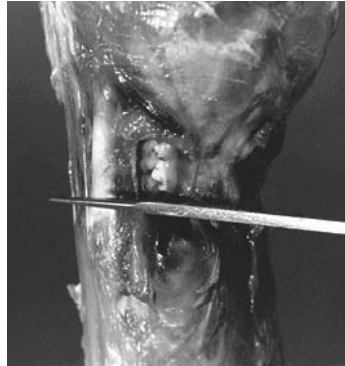
11. Pull the skin down to the ankle.



12. Pull the pelt down over the neck. Cut through the ear cartilage at the skull without cutting the fur.



13. Pull the pelt down to the eyes. Work your knife around the eyelids without cutting the fur.



14. Cut the pelt free at the jaw hinge, and then follow the lips without hitting the teeth. The teeth will dull your knife.



15. Cut through the bottom of the lip and free the pelt. You don't need to skin all the lower jaw. Cut lip half way up.



16. Raccoons have a lot of fat. Work the pelt over the fleshing beam. Put a rag over the nose of the pelt and press your stomach against the beam to hold the pelt. Start scraping just behind the ears, working down the pelt and away from your body using a pushing motion.



17. Pull the pelt up on the beam as you work further down the skin. This picture shows the fleshing knife working the raccoon's stomach area.



18. When you finish fleshing the body, do each leg and the tail. Be careful around the tail so you don't tear it off.

Chapter 16
Handling Fur



19. Slip the pelt over the wire stretcher and adjust it.



20. Hook the tail in place.



21. Hook the back legs.



22. Pull down on the edges of the pelt to stretch it to length. Do not pull hard on the hooks, or they may tear the pelt. Hang the stretched pelt up to dry. Under good conditions this will take four to seven days.



23. Tacking pelt - If using a wood stretcher.



24. Wedge - When using wooden stretchers use tacks to hold the tail and feet in place. Use a wedge between the belly and the board so that you will be able to remove the pelt when it dries and shrinks.

Chapter 17

Responsible Trapping



Content Standard - *Students demonstrate an awareness of their responsibilities to landowners, wildlife, other outdoor users, and the public*

Introduction

Trappers have a legal responsibility to follow regulations. Trappers have a moral obligation to make good decisions when their actions might affect wildlife, landowners, other outdoor users, or the public. Ethical trappers consistently make decisions that result in the greatest good for wildlife, the environment, and people.

Know that there are legal and social obligations to follow trapping regulations

In most situations, trapping is considered a privilege. Society expects trappers to behave in certain ways if they want to trap. That is why we have regulations for seasons, traps, sets, permission to trap, and public safety. A trapper who fails to follow regulations faces possible fines, jail time, and the loss of licenses. Illegal trappers also face disapproval from other trappers and outdoor users. If you want to be accepted by other trappers, you must know the regulations and follow them.

Know that responsible trapping involves many decisions that cannot be defined by law

Laws cannot define what is right or wrong for you in every situation. You must use judgment based on your knowledge, skills, attitudes, and experience to decide what is right or wrong. You can learn from your family or a trusted mentor. In time, you will understand how to make good decisions on your own.

Your relationships with other people, and your social acceptance as a trapper, develop as people come to know how you behave. When you behave in ways

Legal Obligations



FWS Photo

Trappers, hunters, and anglers must know the regulations and follow them to help conserve resources, and to be accepted in the conservation community



that are good for animal welfare, landowners, other outdoor users, and the public, you will be an ethical trapper.

Know that ethics is a system of principles for good conduct

Ethics is a term you should know. Many trappers, hunters, and anglers discuss ethics. Ethics is not a science. Ethics deals with right or wrong in human behavior.

Good behavior in one situation may not be good in another. As an example, if beaver have entered an area where they are causing damage you may choose to take as many as you can. If beaver are scarce on another property, you should take only a few of the animals.

List three specific ways trappers can demonstrate responsible behavior concerning wildlife

Animal welfare is a top concern for the general public, trappers, and other conservationists. You should:

- Know Best Management Practices and use BMP recommended traps and sets to enhance animal welfare
- Work to maintain or improve wildlife habitat and minimize any negative effects your trapping activity might have on vegetation or non-target wildlife
- Report hunting and trapping violations to authorities
- Report suspected wildlife diseases
- Fully use trapped furbearers
- Cooperate with state and federal fish and wildlife management agencies

Ethics

Ethics concerns right and wrong in human behavior. Although it involves the application of human reason, it is not a science.

Definition of Responsible

- Liable to be required to give account, as of one's actions or of the discharge of a duty or trust.
- Involving personal accountability or ability to act without guidance or superior authority.



FWS Photo

A Tradition of Cooperation

Responsible Trapping

Trappers, hunters, and anglers work with resource agencies in many ways



Ohio DOW Photo

Trappers must demonstrate responsible behavior

State and national trapping organizations benefit individual trappers, trappers as a group, and society by promoting conservation and responsible behavior

List three specific ways trappers can demonstrate responsible behavior to the public

Trappers must demonstrate respect toward all other people if they expect to be treated with respect in return. Many people do not understand that wildlife is a renewable resource or that trapping benefits wildlife and people. Your attitudes and behavior will affect people in a positive or a negative way. You should:

- Avoid trapping near property boundaries where you do not have permission unless you contact the people who live there and discuss your plans
- Avoid making sets that might capture pets
- Be able to explain trapping as a highly regulated activity that provides positive benefits to society
- Be a public advocate for animal welfare and wildlife management
- Know the trapping/furbearer regulations and follow them

List three specific ways trappers can demonstrate responsible behavior to other trappers

Trappers must cooperate with each other to ensure the continued use of trapping as an accepted wildlife management technique.

- Join state and/or national trapping organizations so you can learn from others and share your knowledge
- Avoid disturbing another trapper's sets
- Report illegal trappers so their behavior doesn't ruin trapping for everyone
- Help teach new trappers



List three specific ways trappers can demonstrate responsible behavior to hunters and other outdoor users

Millions of North American citizens participate in outdoor activities. Responsible trapping is compatible with other activities at most times and places. To avoid potential conflicts with other outdoor users you should:

- Ask landowners who else might be using their property during trapping season. Communicate with them to find out when and what they might be doing;
- Avoid land trapping on public or private property when hunters may be out in numbers, especially those using dogs;
- Check traps early each morning to remove animals that may be found by dogs or people;
- Wear hunter orange clothing so hunters can clearly identify you as a person;
- Support responsible hunting when hunters need your help;
- Be a responsible steward for all wildlife and habitats.

List three ways trappers can care for and respect natural resources while pursuing and taking furbearers

Trappers should recognize positive and negative values of furbearers and habitat in the environment:

- Avoid destroying living vegetation to make sets
- Trap in areas where furbearers are overabundant
- Decrease your trapping activity in areas where furbearer populations are low
- Don't drive vehicles off the road where you may destroy natural vegetation
- Practice low impact camping



Silvertip Productions

Respect others who use the outdoors, such as birdwatchers



FWS Photo

Responsible trappers respect other people who enjoy using the outdoors

Responsible Trapping



Silvertip Productions

Behave responsibly even when no one is watching



Silvertip Productions

This trapper has earned the respect of landowners. As a result, he has access to thousands of acres of private land for trapping.

- Support the reintroduction of species to areas they once inhabited

Participate in open discussions on the ethics and responsibilities associated with trapping

Group discussions are an excellent way to develop your understanding of ethics and responsibilities. Here are some topics to get you started. For each situation consider:

- What you could do
- What you should do
- What you would do

Scenario 1 - *Your older cousin invites you to go trapping. Along the way, you come to a fence posted with “No Trespassing” signs. As he starts to cross the fence, you ask him “Do we have permission to go there?” He responds, “The owner doesn’t care, and besides, he never comes back here; now come on, let’s go.”*

Scenario 2 - *It is Christmas break from school. You have put out a trapline with more than 3 dozen sets. One afternoon a friend calls and asks you to spend the night and go to an all-day party the next day. It sounds like fun and you really want to go.*

Scenario 3 - *A friend introduces you to a Mr. Smith who is complaining about problems with raccoons on his new 500 acre farm. He gives you permission to trap. On the third day of the season at a remote part of the farm you are confronted by a fox trapper who accuses you of trespassing on property where he claims sole permission to trap. You tell him you have permission from Mr. Smith, but he claims the property is owned by the Jones family, who moved to the city several years ago.*

Scenario 4 - *You are checking your land sets on public land where you haven’t seen anyone else since trapping season opened. Suddenly, you hear several gunshots and turn to see a group of about a dozen hunters in a wide line walking across the field in your direction. As you watch, you can hear the sound of dog bells and beepers coming closer. They are going to pass through an area where you have several foothold traps and cable devices set for coyotes.*



Scenario 5 - *You are trapping on private land where you know the landowner is generous about giving permission to hunters and trappers. You find a muskrat in one of your body-gripping traps at a den site. A man and a young girl approach you and accuse you of stealing fur from their traps. You haven't stolen anything, and you haven't seen anyone else's traps on the property since the season opened. How would you respond?*

Scenario 6 - *It is the second day of trapping season. Before school, you checked your traps and found several muskrats, a mink, and two raccoons. After school you return home and begin the process of skinning and fleshing your fur when three friends show up. One of them is offended to find out that you are a trapper. You don't know what the other two think because they are unusually quiet. What would you say to your friend?*

Scenario 7 - *It is six weeks before the trapping season opens. You show up at a farm to do some scouting where you have permission to trap. The landowner complains about deer damaging his orchard. He comes out of the house with two rifles and says he wants to go along while you scout and have you help him kill several deer. If you turn him down, he may not let you trap on his property anymore. You know that there are too many deer in the area, and the wildlife agency has given several farmers permits to shoot some of them. You don't know if this landowner has a permit, and you are not sure of the rules even if he does have a permit.*

Scenario 8 - *You are out checking your fox traps on a private farm. As you approach a set, you find a fox in someone else's trap set about 30 feet upwind of one of your dirt-hole sets. You can see well in all directions and no one else is around. You've worked hard to do everything right, and you feel like that fox would have been yours if the other trapper had stayed away.*



Silvertip Productions

Trapping instructor passing it on

What could you do?

What should you do?

What would you do?



Silvertip Productions

Adventure awaits -
be responsible

Chapter 18

Furbearers



Arctic Fox

Alopex lagopus; Order: Carnivora; Family: Canidae



The arctic fox has a variable fur color. In summer, they are bluish brown or gray with light undersides. In winter they are white to cream-colored. There is also a blue-phase arctic fox that lives in areas without permanent snow cover. Arctic fox weigh 5.5 to 9 pounds and measure 30 to 36 inches with a 10 to 14-inch bushy tail. Females are smaller than males. The body is compact. Its legs and ears are short, and the footpads are thickly haired, all of which help it conserve heat in subzero weather.

The arctic fox is found in western and northern Alaska, and Northern Canada living in the tundra or on ice floes. They den in hillsides or snowbanks. They eat heavily in the summer and bury food for the winter in the permafrost. Arctic fox follow polar bears and eat leftovers along with rodents, birds, eggs, fish, berries, young seals, and carrion. Breeding occurs from February to May, resulting in one litter of 6 to 12 young.

Badger

Taxidea taxus; Order: Carnivora; Family: Mustelidae



Badgers are wide, flat carnivores with a grizzled gray appearance and a distinctive white stripe from their nose, over their head, and ending between their shoulders. Average adults weigh 12 to 16 pounds, but may increase to 20 or more in the fall. Badgers are well known for their digging ability and fierce disposition. Badgers use multiple elaborate dens with tunnels from 6 to 15 feet deep and as much as 30 feet to an elevated main chamber. Badgers use bedding material and have a separate toilet chamber.

Badgers occur primarily in the western and north central states, with some eastward expansion. They occupy a home range of 3 to 4 square miles of prairie, open farmland, deserts, and woods if the soil is suitable for digging. Badgers eat prairie dogs, gophers, skunks, snakes, birds, eggs, worms, insects, carrion, and berries. Young badgers are eaten by coyotes and eagles. Breeding occurs in August or September with implantation delayed until February. Badgers have one litter a year with 2 to 7 young.



Beaver

Castor canadensis; Order: Rodentia; Family: Castoridae



Beaver are large, bulky rodents capable of altering their habitat by building dams and lodges, but they will also den in river banks. Adults can exceed 60 pounds. The hind feet are large and fully webbed. Beaver have a distinctive, large, flat tail that can be used as a rudder or slapped loudly on the water to sound an alarm. Beaver have sharp teeth, capable of cutting down large trees. Colors vary from blonde to black. The beaver is primarily nocturnal and both sexes have large castor glands beneath the skin on the lower belly.

Beaver range throughout most of the U.S., except for Florida, Nevada, and southern California. Habitats include rivers, streams, marshes, lakes, and ponds. Foods include tree bark, water lilies, and crops. Otters, bears, lynx, bobcats, wolves, and coyotes prey on beaver. In good habitat a beaver's home range will cover up to .6 mile of a stream or river. If food is scarce they may travel as far as 650' from the water. Beaver breed in late January or February and have one litter averaging 4-5 kits.

Bobcat

Lynx rufus; Order: Carnivora; Family: Felidae



Bobcats have short tails. They are colored red, brown, or grey on the back and lighter below with black spots on the front legs and bellies that fade as the animal ages. Bobcats are primarily nocturnal and normally weigh 18 to 22 pounds with females on the smaller side. Large individuals have been reported weighing as much as 76 pounds. Bobcats have retractable claws that do not show up in tracks. Bobcats will wade or swim.

Bobcats range throughout most of the U.S. occupying dense forests, mountains, prairies, farmland, deserts, and swamps, often denning in rock outcroppings. Bobcats eat rabbits, beaver, and occasionally deer. Coyotes, eagles, fisher, wolves, and mountain lions prey upon bobcats. Adult male bobcats sometimes eat juveniles. Breeding occurs during February and March, with one litter a year producing 1 to 4 young. Females breed during the first year, and males at 2 years. Females occupy a home range of about 6 square miles while males may roam over as much as 60 square miles.

Chapter 18

Furbearers



Canada Lynx

Lynx canadensis; Order: Carnivora; Family: Felidae



The Canada Lynx is on the U.S. Endangered Species List and classified as threatened in the lower 48 where it was always rare because its primary prey, the snowshoe hare, is mostly found in Canada and Alaska. Canada Lynx are light gray, with scattered brown to black hair, cinnamon colored underparts and short tails. Males are larger than females, with weights ranging from 11 to 40 pounds.

Canada Lynx are found in Alaska, northern states, parts of the Rocky Mountains, and New England living in coniferous forests, bogs, and swamps. During the day, Canada Lynx rest in cover. They climb trees and often leap down onto prey including snowshoe hares, birds, and voles. They will also eat larger dead animals, or take weakened deer, caribou, or sheep. They pose little threat to humans or domestic animals. Wolves and mountain lions will prey on Canada Lynx. They breed in March or April, producing one litter of 3 to 4 young.

Coyote

Canis latrans; Order Carnovora; Family: Canidae



Coyotes are medium to large canines normally mottled with grey, but sometimes they are brown, reddish, or black. Average weights in the west are 25 to 30 pounds but larger in the eastern U.S. with some individuals reaching as much as 60 pounds. Coyotes are intelligent and adaptable, living in a wide variety of habitats including urban and suburban areas. Coyotes are abundant and they have become less wary of humans in recent years. Attacks on people and pets have been documented.

Coyotes are widely distributed through the U.S. except for Hawaii. Males have a home range of 30 to 40 square miles, females considerably less. Opportunistic feeders, coyotes eat mice, rabbits, insects, reptiles, fawns, carrion, fruits, and seeds. Adult coyotes have few predators, but juveniles are eaten by dogs, mountain lions, and eagles. Breeding occurs in February in the south, and March in the north. Coyotes have one litter a year averaging 3 to 6 pups.



Fisher

Martes pennanti; Order: Carnivora; Family: Mustelidae



Fisher have long slender bodies and range in color from gray brown to dark brown to nearly black with a long, tapering, bushy tail. Males weigh 7.5 to 12 pounds, and females 4.5 to 5.5 pounds. Adult males measure 35.5 to 47 inches in length, with females shorter at 29.5 to 37.5 inches. Fisher have two anal scent glands that produce a foul-smelling liquid. Fisher are primarily nocturnal and travel mostly on the ground, but they are agile tree climbers and sometimes swim.

Fisher are found in the northwest U.S., upper Great Lakes, and New England in dense forests of conifers mixed with hardwoods near water. Nest dens are high in hollow trees, with temporary dens under logs, brush, or tree roots. Fisher travel widely with a home range of 50 to 150 square miles, more if food is scarce. They prey on snowshoe hares, porcupines, rodents, birds, eggs, and carrion. Fisher are eaten by hawks, owls, coyotes, bobcats, and black bears. Breeding occurs in March and April with delayed implantation and birth 51 weeks after mating. Fisher have one litter a year, with 1 to 5 kits. Both sexes are sexually mature at one year of age.

Gray Fox

Urocyon cinereoargenteus; Order: Carnivora; Family: Canidae



Gray fox are small nocturnal canines, more aggressive than red fox, and they have the ability to climb trees for food or refuge. Grays weigh 8 to 11 pounds, heavier in the north, and measure 31 to 44 inches with a 12 to 15 inch black-tipped tail. Fur is gray above and red on the lower sides, chest, and back. Gray fox will cache food. Grays are considered to be easier to trap than red fox, but they do learn and may become trap-wise.

Gray fox are found in eastern states, the southern third of western states, and along the west coast in varied habitats with a preference for more wooded areas. Gray fox have a small home range of one square mile or less. Grays use dens more than red fox, especially in the north. Dens are usually natural cavities marked with snagged hair and scattered bones. Food includes rabbits, other small mammals, birds, insects, plants, and fruit. Bobcats, domestic dogs, and coyotes prey on gray fox. Breeding occurs from January to early May, resulting in one litter averaging 3 to 4 pups.

Chapter 18

Furbearers



Gray Wolf

Canis lupus; Order: Carnivora; Family: Canidae



The gray wolf is the largest wild canine, reaching adult weights of 57 to 130 pounds. It is on the U. S. Endangered Species List except for Alaska, but expanding in population in some areas. Gray wolves can be hunted and trapped in Alaska. Colors range from white to black. Wolves carry their tails straight out, while the smaller coyote holds the tail at a downward angle. Domestic dog's tails curve up.

The gray wolf is found in Alaska, Washington, Idaho, Montana, Minnesota, Yellowstone, and a few other areas, where they prefer forests or open tundra. They live and hunt in packs of 2 to 15 members that range up to 260 square miles. Gray wolves normally eat close to four pounds of food a day, but can go long periods between meals. They hunt at night feeding on moose, caribou, deer, berries, birds, fish, and insects. Gray wolves seldom use dens, except for maternity dens. Wolves are sexually mature at two, breed during late January to February, and produce one litter a year averaging 5 to 6 pups.

Kit Fox

Vulpes macrotis; Order: Carnivora; Family: Canidae



The kit fox is a small, long-legged canine with large ears. It is yellowish above and lighter below with a prominent black-tipped tail, and weighs 3 to 5 pounds. It is 24 to 31 inches in length, with a 9 to 12-inch tail. Some people consider the kit fox to be a sub-species of the more easterly swift fox.

The kit fox is found in arid grassland regions of Oregon, California, Idaho, Nevada, Utah, New Mexico, Arizona, Texas, and Colorado. They eat rodents and rabbits. The San Joaquin Kit Fox is an endangered subspecies due to the destruction or alteration of the grasslands where it lives. Kit fox breed from January to February, producing one litter of 3 to 5 young a year.



Marten

Martes americana; Order: Carnivora; Family: Mustelidae



Marten are small weasel-like woodland mammals varying from light to dark brown with a bushy tail and orange throat. It weighs from 1 to 3.5 pounds, with males larger than females. Marten are active in the early morning, late afternoon, at night, and on cloudy days. They can climb trees, but spend most of their time on the ground foraging for rodents. Their large feet allow them to walk on snow. Marten sometimes bury meat and both sexes establish scent posts.

Marten range from New England to the northern Great Lakes states, the Rocky Mountains, and the northern west coast living in coniferous forests with numerous dead trees and debris. Their home range is as small as one square mile but the range varies with sex, food availability, and habitat. Marten den in hollow trees, fallen logs, rocks, squirrel nests, and woodpecker holes. Food includes red-backed voles, other rodents, red squirrels, and birds. Fisher and owls prey on marten. Breeding occurs in July with delayed implantation. They have one litter a year with 1 to 6 young. Both sexes breed during their second year of life.

Mink

Mustela vison; Order: Carnivora; Family: Mustelidae



Mink are small nocturnal carnivores with short dense fur shaded chocolate to nearly black with small patches of white on the chin, throat, or belly. Some have light fur and they are known as cotton mink. Males measure 20 to 30 inches with weights over 3 pounds, while females are smaller at 16 to 21 inches and 1.5 to 2 pounds. Mink have glands in the anal area that can release a powerful, unpleasant smelling musk. They are quick on land, skilled swimmers, and capable tree climbers.

Mink are widely distributed across the U.S. except for the southwest and Florida. They inhabit streams, rivers, marshes, lakes, and ponds. Males range widely over routes of 25 miles or more, while females stay close to their dens in holes, hollow logs, rock piles, beaver lodges, muskrat lodges, or abandoned muskrat dens. Males maintain numerous dens and often cache food in some of them. Mink eat muskrats, crayfish, frogs, fish, rabbits, birds, insects, and snakes. Owls, fox, coyotes, bobcats, and dogs prey on mink. Breeding occurs in late February or early March with delayed implantation. They have one litter a year with an average of four young.

Chapter 18

Furbearers



Muskrat

Ondatra zibethica; Order: Rodentia; Family: Cricetidae



U.S. Fish and Wildlife Service Photo

Musk rats are small rodents with dense glossy brown fur and a hairless tail, weighing 1 to 2 pounds in the south and 3 to 4 pounds in the north. Total length varies from 19 to 25 inches. Musk rats are nocturnal and can swim forwards and backwards with the aid of partially-webbed hind feet. Males have prominent musk glands beneath the skin on their lower abdomen that swell in the spring and produce a yellowish musky-smelling fluid.

Musk rats are found throughout most of North America except for the arctic, most of California, Texas, Florida, and the southwest.

Habitats include marshes, lakes, ponds, streams, and ditches where they feed on aquatic plants such as cattails, rushes, and water lilies. Mink, fox, coyotes, hawks, and owls eat muskrats. Musk rats burrow into banks of streams and ponds, and they build prominent lodges out of cattails or other vegetation in marshes and lakes. They have a small home range, seldom traveling more than 200 feet from their den. Breeding occurs from late winter to September in the north, and year-round in the south, producing 1 to 5 litters a year and 1 to 11 young per litter. Musk rats are sexually mature at six months of age.

Nutria

Myocastor coypus; Order: Rodentia; Family: Myocastor



U.S. Fish and Wildlife Service Photo

Nutria are large rodents introduced to the U.S. from South America that create habitat problems in some areas. They have a negative impact on muskrats, waterfowl, and other native wildlife. Nutria weigh 5 to 25 pounds and measure up to 24 inches with a long, scaly, rounded tail that stretches another 12 to 17 inches. Males are larger than females.

Nutria are found in scattered locations including Texas, Louisiana, Mississippi, Alabama, Georgia, Florida, North Carolina, Virginia, Washington, and Oregon where they occupy marshes, lakes, ponds, and streams. Dominant males share a den with 2 or 3 females and the young. Den entrances are 12 to 24 inches below the water and as much as 24 inches in diameter. The inner chamber is above the waterline and lined with grasses. The home range usually includes about 1,000 feet of habitat along a dike or shoreline. Nutria eat most any green plant and grains. Alligators, hawks, owls, and eagles prey on nutria. Breeding occurs throughout the year with 1 to 11 young per litter. Sexual maturity is at 5 to 6 months.



Opossum

Didelphus virginiana; Order: Didelphimordia; Family: Didelphidae



Opossums are the only marsupial in North America. They have a fur-lined pouch, and a prehensile, flesh-colored or whitish tail. The fur is grayish-white. Males average 6 to 7 pounds, up to 14 pounds, while females are smaller. Total lengths range up to 36 inches. Opossums are nocturnal and known for the habit of “playing dead” when threatened. They are strong climbers and swimmers.

Originally opossums were restricted to the southeast U.S., but spread widely due to human activity after European settlement. They are now found throughout the eastern U.S. and on the west coast. Habitats include deciduous woodlands near water, but they are also suburban pests. Opossums make leaf nests in hollow logs, fallen trees, or abandoned burrows. Home ranges are small from 10 to 200 acres. Opossums are omnivorous, eating nearly any plant, animal, insect, or carrion. Coyotes, fox, raccoons, bobcats, eagles, snakes, hawks, and owls prey on opossums. Most breeding occurs in February and litters have 5 to 13 young, which stay in the pouch for 60 days. Opossums are sexually mature at 6 to 8 months.

River Otter

Lontra canadensis; Order: Carnivora; Family: Mustelidae



Otters are long, slender, short-haired furbearers known to be playful and intelligent. The fur is a rich, glossy, shade of brown and lighter on the cheeks, throat, and belly. Males grow to 48 inches and 25 pounds while females are 4 to 6 inches shorter and 19 pounds or less. Both sexes have anal musk glands that release when the animal is frightened. The musk is less pungent than other mustelids. Otters have webbed toes and non-retractable claws. They also have valves in their nose and ears that close when they are underwater.

Otters range over Alaska, the Pacific Northwest, Great Lakes States, the Mississippi River Valley, to the Atlantic and Gulf Coastal states. They inhabit remote rivers, lakes, wetlands, and beaver ponds eating fish, frogs, crayfish, mollusks, beaver, muskrats, and vegetation. Adult otters are rarely killed by other animals with some predation by lynx, wolves, bobcats, and coyotes. The home range varies from 450 to 14,000 acres or 5 to 50 linear miles of shoreline. Otters infrequently use dens but may occupy old beaver dens and lodges. Otters mate at 2 years of age. Breeding occurs in March and April resulting in one litter a year of 2 to 3 young.

Chapter 18

Furbearers



Raccoon

Procyon lotor; Order: Carnivora; Family: Procyonidae



Raccoons are medium size adaptable furbearers with a masked face and ringed-tail. Average weights are 9 to 20 pounds, but larger in the north where weights up to 62 pounds have been reported. Fur color varies from dirty blonde with darker guard hairs to reddish and darker colors. The hind legs are longer than the front ones, creating a hunched appearance when running.

U.S. Fish and Wildlife Service Photo

Raccoons are widely distributed across the U.S. where they use varied habitats from streams, rivers, lakes, and wetlands to forests, prairies, farmland, and urban areas. Home ranges vary by habitat from 15 acres in urban environments to 12,000 acres in prairies. Raccoons den in hollow trees, ground burrows, brush piles, muskrat houses, barns, buildings, clumps of cattails, haystacks, and rock crevices. They are omnivores eating fish, crayfish, mussels, fruits, grains, small animals, birds, and muskrats. Coyotes, bobcats, mountain lions, owls, eagles, and fishers prey on raccoons. Breeding occurs in January in the north to March in the south. Litters average 2 to 5 young, up to 8. Females breed their first year, males at two years of age.

Red Fox

Vulpes vulpes; Order: Carnivora; Family: Canidae



Red fox are small, shy, and adaptable with a capacity for learning from experience. Red fox weigh 10 to 12 pounds, but heavier in the north up to 14 pounds. Lengths range from 35 to 41 inches with a 14 to 17 inch bushy tail tipped in white. Commonly red on top, gray to white lower, with black on the ears, lower legs, and feet. Other color phases include black, silver, and crosses between red and silver. Red fox are primarily nocturnal and have the ability to hear low frequencies that let them detect small prey underground.

Red fox are widely distributed across the U.S. except for parts of the west. Habitats include mixed cultivated fields, woodlots, and brushland. The home range is generally 2 to 3 square miles, but varies with habitat and prey. Red fox eat small mammals, birds, insects, crayfish, corn, berries, acorns, and other vegetation. Coyotes prey on red fox and trappers often note lower red fox populations when coyotes increase in number. Red fox use maternity dens to raise their young. The dens are often old woodchuck or badger diggings on slopes with good visibility. Breeding occurs in January to early March, resulting in one litter of 1 to 10 kits.



Ringtail/Bassarisk

Bassariscus astutus; Order: Carnivora; Family: Procyonidae



Ringtails have cat-like bodies and long, bushy tails with 14 to 16 distinct bands of black and white. They weigh 2 to 2.5 pounds. Some people call them “miner’s cats” because were once used in mines to control rats. During the day they stay in dens. They can climb trees or walls, and they are excellent leapers.

The ringtail’s range includes southwest Oregon, California, Nevada, Utah, Colorado, Kansas, Arizona, New Mexico, Oklahoma, and Texas. They live in rocky areas, or sometimes wooded areas with hollow trees. A varied diet includes insects, snakes, lizards, toads, frogs, birds, small mammals, carrion, and fruit. They breed in April producing one litter of 2 to 4 young.

Striped Skunk

Mephitis mephitis; Order: Carnivora; Family: Mustelidae



Striped skunks are small, heavy-bodied, black animals with two white stripes on the back that meet and form a white cap on the head. Skunks measure 20 to 30 inches and weigh 3.5 to 10 pounds. They are well known for their ability to spray a stong-smelling, yellowish, oily fluid for protection. Primarily nocturnal, skunks have poor eyesight, keen hearing, and a strong sense of smell. Skunks are capable of swimming, but they are poor climbers.

Striped skunks are widespread across North America where they inhabit open fields, farms near water, urban, and suburban areas.

The home range is small, generally less than one square mile in size. Skunks are omnivores, eating insects, rodents, eggs, carrion, and vegetation. Owls, coyotes, bobcats, fox, badger, lynx, fisher, golden eagles, and mountain lions will prey on skunks. Skunks use dens abandoned by other animals or hollow logs, and may use communal dens with other animals. Breeding occurs from February to April producing one litter of 2 to 10 young per year. They are sexually mature at 8 to 9 months of age.

Chapter 18

Furbearers



Swift Fox

Vulpes velox; Order: Carnivora; Family: Canidae



The swift fox is similar to the kit fox but lives in prairies east of the Rocky Mountains. The swift fox has longer ears with bases closer to the center of the skull, a more rounded and dog-like head, and a tail that is shorter than the kit fox in relation to body length. The swift fox is primarily nocturnal. Populations have declined due to conversion of prairies to croplands, overgrazing, and poisoning.

Weasels

Mustela frenata, *Mustela erminea*; Order: Carnivora; Family: Mustelidae



Weasels are small furbearers with short fur, generally light brown above and cream-colored on the throat and belly, with black-tipped tails. In northern areas their coats change to white in the winter, and these are called ermine. Adult long-tailed weasels (*M. frenata*) measure 13 to 17 inches including a 4.5 to 6.5 inch tail. Males are larger than females. Short-tailed weasels have tails 4 inches long or less. Weasels are primarily nocturnal.

Long-tailed weasels are widely distributed in the U.S., except for the southwest, while short-tailed weasels are in most of the far northern states. Habitats include mountains, farmland, forests, and prairies near water. Weasels generally stay within a half-mile of their den. They eat mice, voles, chipmunks, rabbits, birds, eggs, and poultry. They are eaten by fox, mink, coyotes, bobcats, hawks, and owls. Both sexes use a single den in hollow stumps, tree roots, rock piles, or under old buildings. Dens are lined with grasses and fur from prey animals. Weasels breed in July with delayed implantation, producing one litter with an average of six young. Females mate at 3 to 4 months, males during their second year of life.



Wolverine

Gulo luscus; Order: Carnivora; Family: Mustelidae











Wolverines are the largest terrestrial member of the weasel family, resembling a small bear, but moving and behaving like weasels. Their fur is thick, glossy, and dark brown, sometimes with a light face mask. A stripe runs from the shoulders, down the sides, and over the rump. They have a bushy tail. Males grow to 44 inches and 40 pounds, while females are about 25% smaller. They can release musk from their anal glands.

Wolverines are found in Alaska, Canada, and parts of Idaho, Montana, Washington, and Oregon where they inhabit boreal forests and tundra. They feed on rodents and scavenge for food including deer, caribou, and moose, but they also raid traps and cabins. Wolverines cover a large home range of 1,000 square miles or more. They travel with a slow lope, but they can swim and they are quick climbers. Mating occurs from April to September, but implantation is delayed until winter, producing one litter of 2 to 5 young.

Chapter 18 Furbearers



 <p>Arctic Fox Front/Rear-2.5"W 2.5"L</p>	 <p>Badger Front-2"W 1.5"L, Rear-1.75"W 2"L</p>	 <p>Beaver Front-2"W 2"L, Rear-4"W 6"L</p>	 <p>Bobcat Front/Rear-1.75"W 2"L</p>
---	---	---	--

 <p>Canada Lynx Front/Rear-3.25"W 3.25"L</p>	 <p>Coyote Front-2"W 2.5"L, Rear-1.5"W 2"L</p>	 <p>Fisher Front/Rear-2.5"W 2"L</p>	 <p>Gray Fox Front/Rear-1"W 1.5"L</p>
---	---	---	--




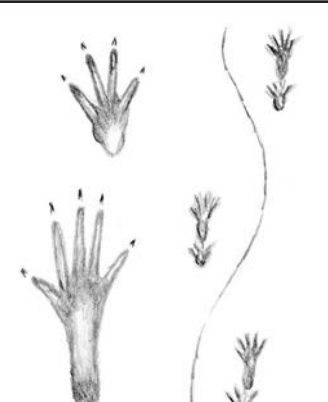
 <p>Kit Fox/Swift Fox Front/Rear-1.25"W 1.25"L</p>	 <p>Marten Front/Rear-1.5"W 1.5"L</p>	 <p>Mink Front/Rear-1.5"W 1.25"L</p>	 <p>Muskrat Front-1"W 1"L, Rear-1"W 2.5"L</p>
--	---	---	---

Image Credits - Mary Wentz, Silvertip Productions

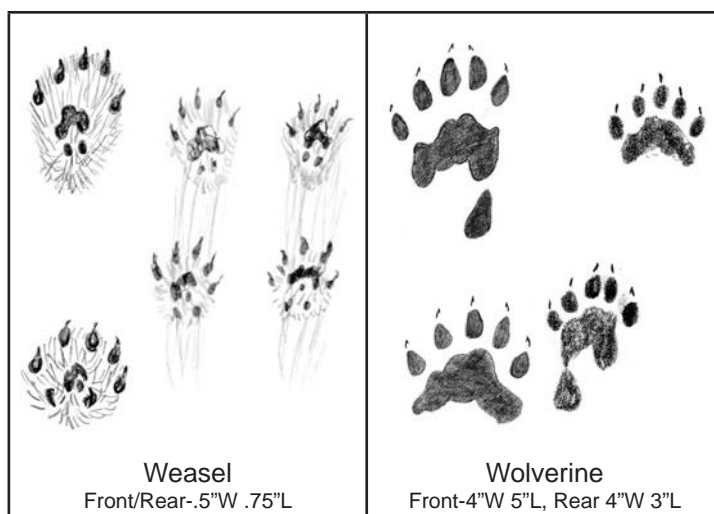
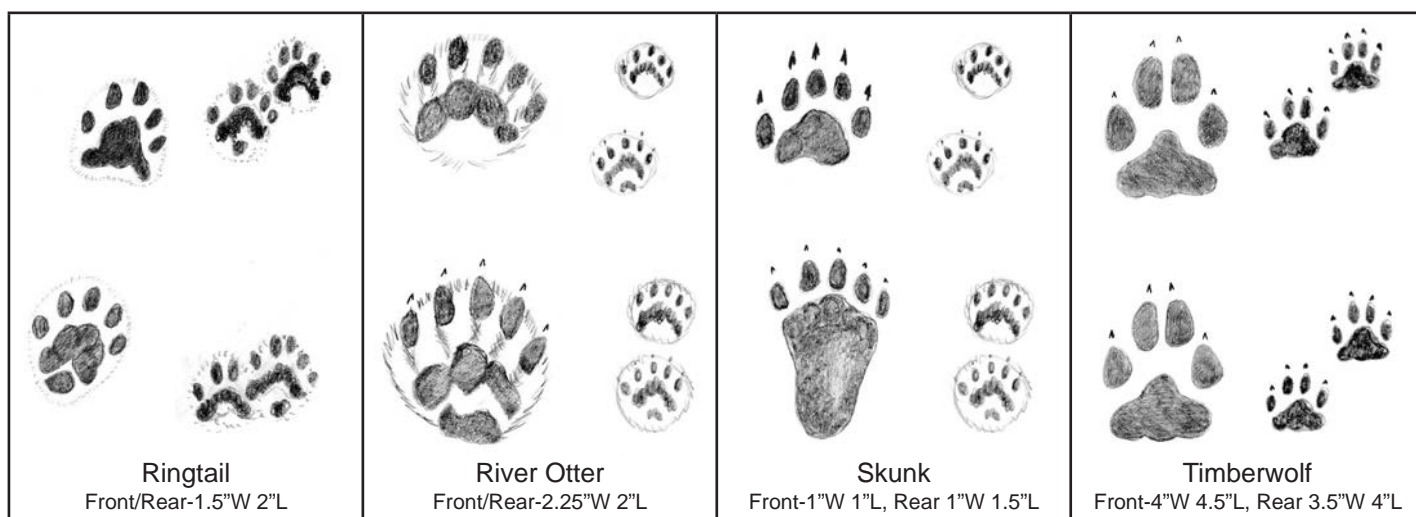
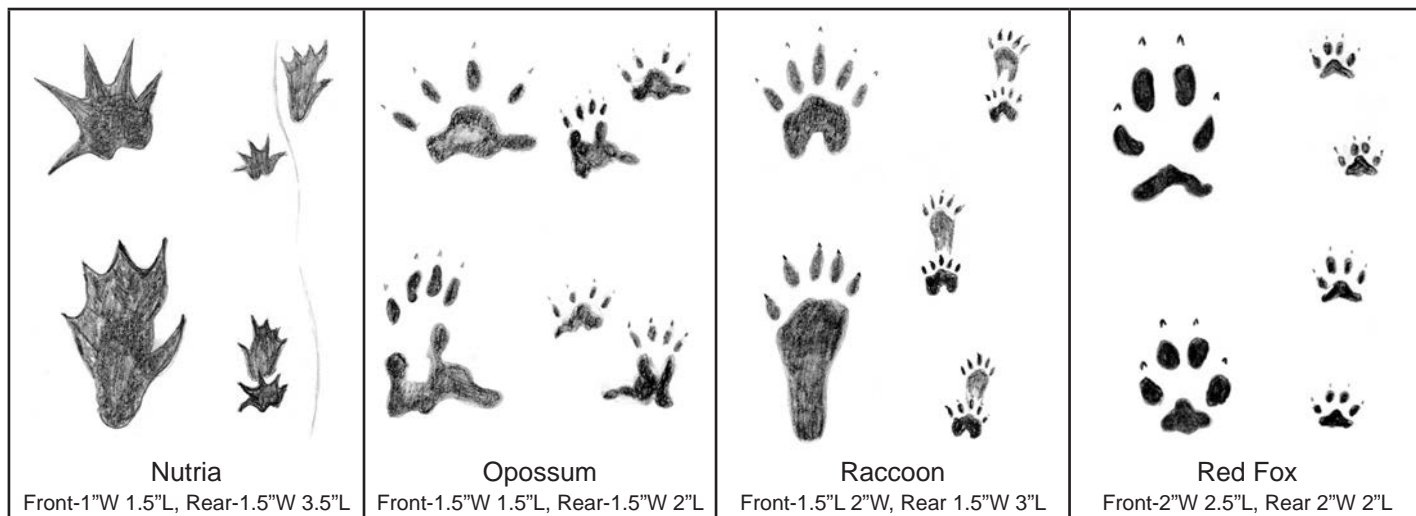


Image Credits - Mary Wentz, Silvertip Productions

Appendix A

Traps, Sets, & Attractors

Furbearer	Traps	Sets	Bait & Lure
Coyote	#1.5 - 3 Coil-spring Cable devices Belisle cable device	Dirt-hole, flat, post, cable restraints	Bait: Covered meat or fish Lure: Fox or coyote lure, urine
Red Fox	#1.5 - 3 Coil-spring Cable devices Belisle cable device	Dirt-hole, flat, post, cable restraints	Bait: Covered meat or fish Lure: Fox lure, urine
Gray Fox	#1 - 2 Coil-spring Cage trap Belisle cable device	Dirt-hole, flat, post, cable restraints	Bait: Covered meat, eggs, fish Lure: Fox lure, urine
Gray Wolf	Locking or powered cable devices. Check with wildlife agency for regulations and methods	Dirt-hole, flat, post, cable restraints	Bait: Covered meat Lure: Canine lure or urine
Swift/Kit Fox	#1.5-1.75 Coil-spring Cable devices	Dirt-hole, flat, post, cable restraints	Bait: Covered meat or fish Lure: Fox lure, urine
Arctic Fox	#1.5-1.75 Coil-spring Cable devices	Dirt-hole, flat, post, cable restraints	Bait: Covered meat or fish Lure: Fox lure, urine
Beaver	#330 Body-gripping traps 3/32" Cable devices Live traps	Climb out, scent mound, channel, open water beaver set, under-ice	Bait: Small sticks of poplar, willow, cottonwood Lure: Commercial or home-made castor scents
Muskrat	#110 - 120 Body-gripping traps #1 - 1.5 Long-spring Guarded long-spring Colony trap	Feedbed, trail, pocket, runway, floating	Bait: Apples, carrots, ear corn, turnip, orange peels Lure: Musk glands from male muskrats
Nutria	#1 - 1.5 Padded coil-spring Guarded long-spring Mid-size body-gripping Note: Brackish water weakens coilsprings. When trapping for fur, nutria under 12 pounds are released. When trapping for control, all are killed.	Runway, climb out	Bait and lure not effective
Bobcat	#1.5 - 3 Coil-spring, #3 Long-spring Belisle cable device	Dirt-hole or cubby	Bait: Fish, beaver or rabbit meat Lure: Anise, catnip, fish oil, beaver castor, other glands
Canada Lynx	#330 Body-gripping traps #3 Long-spring Cable devices Belisle cable device	"Cubby" made from sticks in teepee shape against tree, trail set with cable devices	Bait: Fish, beaver or rabbit meat Lure: Anise, catnip, fish oil, beaver castor, other glands
Mink	#1 - 1.5 Foothold traps #110 - 160 Body-gripping traps Cage traps - 6x6x20"	Pocket, trail, cubby, channel, obstruction	Bait: Chunks of fish or fresh muskrat Lure: Mink/muskrat musk, scat, urine, fish oil
River Otter	#220-330 Body-gripping	Otter latrine or channel sets	Bait: Fresh fish or muskrat Lure: None recommended

Trapper Education Manual

Fisher	#160 - 220 Body-gripping traps #1.5 - 2 Foothold Cage traps	Dirt-hole, cubby, leaning pole	Bait: Raccoon or porcupine meat, fish Lure: Fisher musk & urine, beaver castor, skunk essence
Marten	#1 Long-spring #120 Body-gripping trap	Cubby, running pole	Bait: Chunks of meat or fish, strawberry jam Lure: Skunk essence
Weasels	#1.5 Coil-spring, #0 - 1.5 Long-spring Victor rat trap #50 - 110 Body-gripping traps	Cubby, traps in boxes or hollow logs	Bait: Bloody meat or rabbit Lure: Weasel gland scent
Striped Skunk	#1 - 1.5 Long-spring or coil-spring Cage traps #160 - 220 Body-gripping traps	Dirt-hole, cubby	Bait: Fresh or tainted meat, fish, or eggs Lure: Fish oil, skunk musk, anise, honey
Opossum	#1 - 1.65 Coil-spring Enclosed Foothold traps Cage trap	Dirt-hole, cubby	Bait: Jelly, jam, fruit, meat eggs, cheese, fish Lure: Not necessary
Raccoon	#1 - 1.5 Coil-spring, #11 Long-spring traps Enclosed foothold traps Cage traps #160 or 220 Body-gripping traps	Pocket, cubby, spring run, cage, dirt-hole	Bait: Chunks of fish or muskrat Lure: Fish oil, anise, honey, hard candy
Bassarisk Ringtail	#220 Body-gripping traps #1.5-1.75 Coil-spring traps	Cubby, dirt-hole, flat	Bait: Meat Lure: Commercial Lure
Wolverine	#280 or 330 Body-gripping traps Note: Few trappers will ever encounter wolverines. If you trap an area where wolverines are legal consult the wildlife agency for regulations and methods.	Sets at established bait stations or wolf kills. Post or trail sets	Bait: Meat Lure: Wolverine gland, beaver castor, fish oil
Badger	#1.75-3 Coil-spring #220 Body-gripping traps Cage traps	Dirt-hole sets at burrow entrance	Bait: Fresh or tainted rodent or beaver meat Lure: Badger gland scent

Appendix B

Pelt Preparation

Furbearer	Pelt Preparation	Stretcher Size - Inches				
		Size	Length	Base	Shoulder	Neck
Coyote	Skin cased, split tail. May be little fat or flesh. Pelt immediately. Turn pelt fur side out when skin is dry to the touch	Large	75	13	9.5	14
		Average	70	12	9	13
		Small	65	11	8	12
Red Fox	Skin cased, split tail. May be little fat or flesh. Pelt immediately. Turn pelt side out when skin in dry to the touch	Large	56	8	6	11.5
		Average	54	7	5	11
		Small	50	6.5	4.5	10
Gray Fox	Skin cased, split tail. Gray fox have more to flesh than red fox. Pelt immediately. Turn pelt side out when skin is dry to the touch.	Large	56	9	6	11.5
		Average	54	7	5	11
		Small	50	6.5	4.5	10
Gray Wolf	Skin cased, split tail. Pelt immediately. Leave claws on pelt. Turn pelt side out when skin is dry to the touch.	Large	96	11.5	8	12
		Small	75	10	7.75	12
Swift/Kit Fox	Same as Red Fox					
Arctic Fox	Same as Red Fox					
Beaver	Skinned open, dried in oval shape by nailing on pattern board, or sewn to hoop. If nailed, lift pelt on nails a short time after boarding. This allows air to circulate between pelt and board.					
Muskrat	Skin cased with tail removed, don't overflesh, market fur in	Large	22	20	6.5	6
		Average	21	7.5	6	5.5
		Small	20	7	5.5	5
Nutria	Skin cased, tail off, fur side in; flesh carefully to avoid tears. Pelts less than 23 inches have no value. Special wire stretchers are used for nutria, 7 to 7.5 inches at base, straight sides. The base of the pelt is tacked to a sliding wooden block to give it a squared off shape as it dries.					
Bobcat	Skin cased, remove claws, remove all flesh and fat, market fur out	Large	70	10	7	12
		Average	60	9	6.5	11
		Small	48	7	5	10
Canada Lynx	Skin cased, remove claws, remove all flesh and fat, market fur out	Large	70	10	7	12
		Average	60	9	6.5	11
		Small	48	7	5	10
Mink	Skin cased, split tail, market fur side in, fleshed lightly	Large male	40	5	3.25	8.5
		Large female	36	4	3	8
River Otter	Skin cased, cut front legs short and sew closed, pin tail in V shape, market fur in	Large	65	8	6.75	15
		Average	58	7.5	6	13.5
		Small	32	7	5	9
Fisher	Skin cased, flesh well, market fur out	Large male	50	8	6	10
		Large female	48	7	5	9.5
Marten	Cased, split tail, market fur side out, little or no fleshing needed	Large male	40	5	3.25	8.5
		Large female	36	4.5	3	7
Weasels	Skin cased, market fur in, remove tail bone but do not split the tail	Large	22	3	2.5	5.5
		Average	16	2.5	1.75	4
		Small	12	1.75	1.25	3
Striped Skunk	Skin cased, flesh well, market fur in	Large	40	8	6	10.5
		Average	38	7.5	5.5	10
		Small	34	7	5	9

Trapper Education Manual

Opossum	Skin cased, tail off, fur side in; flesh carefully to avoid tears	Large Average Small	38 36 32	8 7.5 7	6 5.5 5	10.5 10 9
Raccoon	Skin cased, tail split. Remove all flesh & fat; market fur in	Large Average Small	48 42 34	10 9 8	7.5 6.5 5.5	12.5 12 11.5
Bassarisk Ringtail	Check with your furbuyer for current recommendations. Taxidermists may want this species, and be willing to pay a higher price than a furbuyer.					
Wolverine	Cased and fur out, leave lower lip on, keep claws attached	Few trappers will ever encounter a wolverine. If you live in an area where it is legal to trap wolverine, obtain current information on pelt preparation from a furbuyer.				
Badger	Skin open, skin out tail and leave attached, board with head & tail in triangular shape, legs extended from body.					

